

CATÁLOGO DE PRODUCTOS

 **MORELLI**



NOSSA HISTÓRIA

A Morelli nasceu em 1980 de uma ideia inovadora, na cidade paulista de Sorocaba.

Com mais de 37 anos de atuação, a Morelli é uma indústria especializada na fabricação de produtos ortodônticos. Ocupando hoje uma área de 20 mil m², onde são produzidas mais de 20 milhões de peças mensais de um portfólio de mais de 2.000 itens.

Baseada no empreendedorismo, a Morelli é pioneira da indústria brasileira de produtos para Ortodontia.

A empresa surgiu em um cenário conturbado, marcado pela instabilidade política e econômica. Em meio a este panorama, a visão inovadora e empreendedora de nosso fundador, permitiu a Morelli atender as necessidades do mercado ortodôntico nacional.

Hoje, com uma rede de mais de 180 revendedores no Brasil e presença em mais de 30 países, a Morelli reforça a cada dia sua atuação no mercado.

A constante evolução tecnológica de nossos produtos é um dos pilares de nossa filosofia, garantindo alto grau de qualidade e excelência.

 **MORELLI**

Desde 1980 compartilhando Sorrisos!

Índice

Bráquetes / Brackets	05
<hr/>	
Prescrições: Roth, Capelozza, Ricketts, Edgewise, M.B.T.	
Tubos / Tubes	36
<hr/>	
Prescrições: Roth, Capelozza, Edgewise, Ricketts, M.B.T, Lingual	
Acessórios / Accessories	42
<hr/>	
Ancoragem Absoluta / Absolute Anchorage	52
<hr/>	
Bandas / Bands	56
<hr/>	
Arcos / Archwire	66
<hr/>	
Fios / Wires	74
<hr/>	
Elásticos / Elastics	78
<hr/>	
Ortopedia Funcional / Functional Orthopedics	84
<hr/>	
Casquetes e Tracionadores / Headgear and Tractors	88
<hr/>	
Instrumentos / Instruments	92
<hr/>	
Higiene Bucal / Oral Hygiene	102
<hr/>	
Compartimentos / Compartments	104
<hr/>	
Adesivos / Adhesives	108
<hr/>	

BRÁQUETES



Especificações Ortodônticas

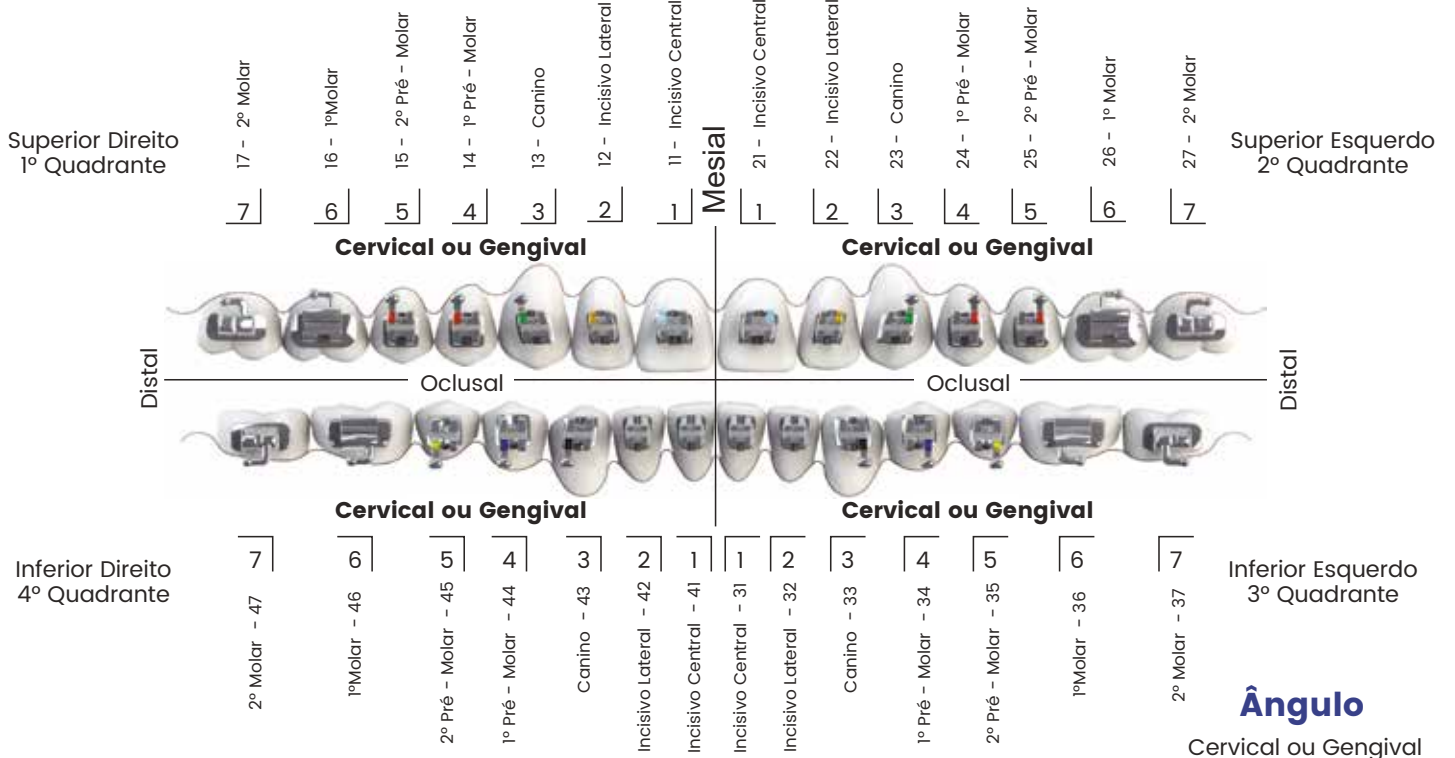

Ângulo

Cervical ou Gengival

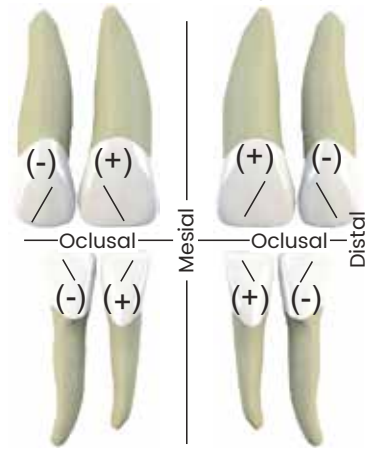

Torque

Cervical ou Gengival

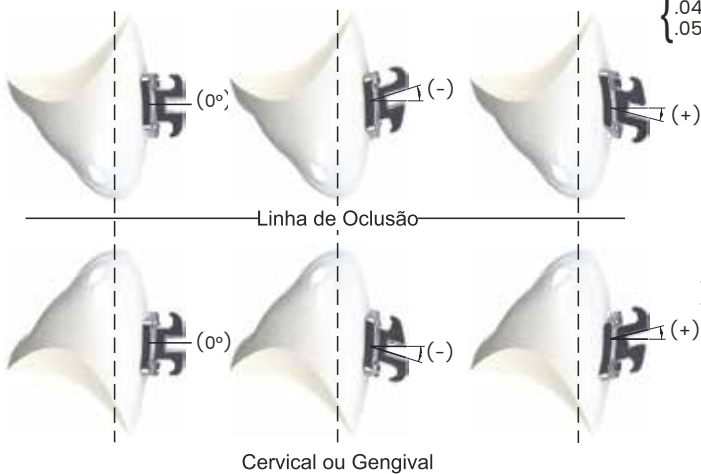

Slot

(∅) Diâmetro do Olhal
.045" → 1,15mm
.051" → 1,30mm

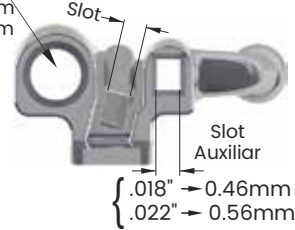

.018" → 0,46mm
.022" → 0,56mm



ARCADA DENTÁRIA

Maxilar
Vestibular ou Labial

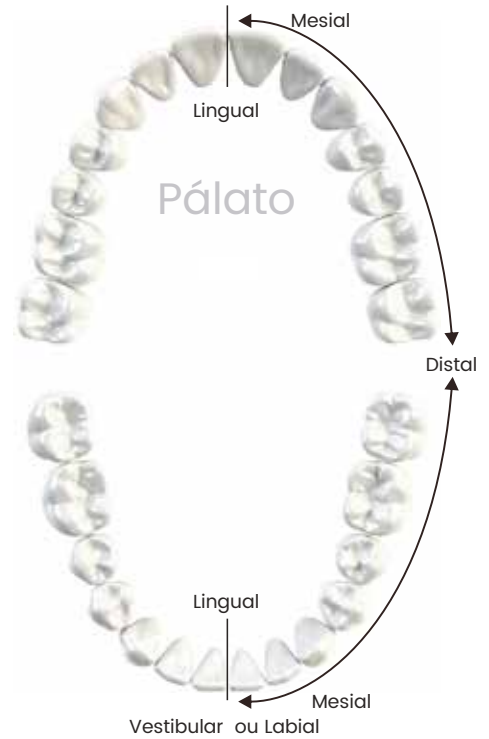

IN / OUT (IN-SET / OFF-SET)

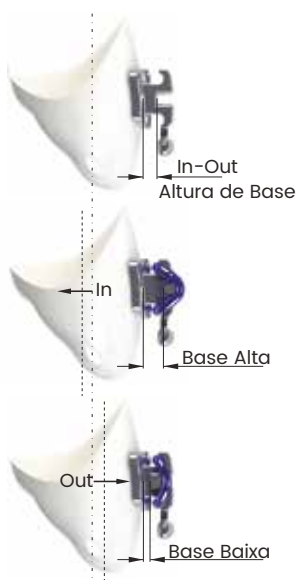

COMPRIMENTO



CURVATURA DA BASE



DISTAL OFFSET

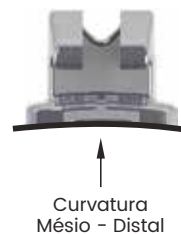

Guia rápido de Kits Morelli

Prescrição

Modelo

com gancho		
Caninos	Pré-molares	Ângulo canino superior

1 Caso
20 peças
Back .022" Front .018"

10 Casos
200 peças
Back .022" Front .018"

100 Casos
2000 peças
Back .022" Front .018"

Página

Modelo	Caninos	Pré-molares	Ângulo canino superior	1 Caso (20 peças)	10 Casos (200 peças)	100 Casos (2000 peças)	Página			
Roth Autoligado SLI	●	●	9°	10.14.900			09			
Autoligado SLP	●	●	9°	10.13.900			09			
Autoligado SLH	●	●	9°	10.23.900			10			
Ceramic SLI	●	●	9°	10.12.900			10			
Ceramic	●	●	9°	10.11.900			12			
Composite	●	●	13°	10.17.901	10.17.932		13			
Light			13°	10.10.907	10.10.906		15			
Light			9°	10.10.915			16			
Light	●		13°	10.10.961	10.10.960		16			
Light	●		9°	10.10.963			17			
Light	●	●	13°	10.10.979	10.10.978	10.10.996	17			
Light	●	●	9°	10.10.981		10.10.997	18			
Light Biofuncional	●	●	13°	10.10.920			18			
Monobloc	●	●	13°	10.15.901			15			
Max	●	●	9°	10.15.903	10.15.902	10.15.933	10.15.932	10.15.923	10.15.922	14
Max	●	●	13°	10.15.905	10.15.904	10.15.935	10.15.934	10.15.925	10.15.924	14
Nano	●	●	9°	10.15.906				22		
PolySafira	●	●	9°	10.24.900				12		
Standard			13°	10.10.901	10.10.900			19		
Standard			9°	10.10.911				19		
Bidimensional	●	●	9°	10.15.930				22		
Standard	●		13°	10.10.951	10.10.950			20		
Standard	●		9°	10.10.953				20		
Standard	●	●	13°	10.10.969				21		
Standard	●	●	9°	10.10.971				21		
Edgewise Ceramic	●	●		10.18.901				14		
Slim Max				10.65.905	10.65.904	10.65.935	10.65.934	27		
Slim Max	●			10.65.907	10.65.906	10.65.937	10.65.936	28		
Slim	●			10.65.901	10.65.900			29		
Standard				10.30.901	10.30.900			28		
M.B.T. Light				10.35.904				25		
Light	●	●		10.35.903				25		
Max		●		10.35.906		10.35.936		23		
Max	●	●		10.35.905		10.35.935		23		
Standard				10.35.901				24		
Standard	●			10.35.902				24		
Ricketts Capellozza Max Padrão I	●	●		10.19.904		10.19.934		26		
Max Padrão II	●	●		10.19.905		10.19.935		26		
Max Padrão III	●	●		10.19.906		10.19.936		27		
Actual	●	●			10.25.901			32		
Actual Especial	●	●			10.25.900			32		
Slim	●	●			10.25.905			33		

Uma peça **prática, moderna** e de **alta tecnologia**



O autoligado Morelli é o melhor bráquete de sua categoria, com qualidade e propriedades mecânicas superiores.

O clip de Nitinol utiliza a memória de forma para proporcionar segurança no deslize dos fios em um alinhamento rápido, mesmo em condições extremas de apinhamento.

A abertura e fechamento do clip pode ser realizada pelo explorador, sem a necessidade de ferramentas específicas.

Disponível na versão **Interativa**
e na versão **Passiva**.



SLI
Self Ligating Interactive

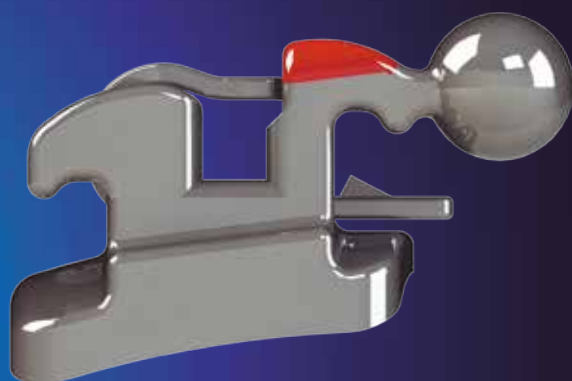

SLP
Self Ligating Passive

Morelli SLI Prescrição Roth (Autoligado Interativo) com ganchos nos caninos (9°) e pré-molares



Kit 20 peças / pieces
10.14.900

Slot
.022"

Comprimento Length	
Torque Torque	
Ângulo Angle	

3,0 mm	3,0 mm	3,0mm	2,9 mm	2,9 mm	2,9 mm	2,9 mm	3,0 mm	3,0 mm	3,0 mm
-7°	-7°	-2°	+8°	+12°	+12°	+8°	-2°	-7°	-7°
0°	0°	+9°	+9°	+5°	+5°	+9°	+9°	0°	0°

Reposições
Replacements
5 peças / Pieces
.022"

10.14.007	10.14.007	10.14.005	10.14.003	10.14.001	10.14.002	10.14.004	10.14.006	10.14.008	10.14.008
------------------	------------------	------------------	------------------	------------------	------------------	------------------	------------------	------------------	------------------

Abertura do clip no sentido oclusal

Maxilar



Mandibular



Comprimento Length	
Torque Torque	
Ângulo Angle	

3,0 mm	3,0 mm	3,0 mm	2,7 mm	2,7 mm	2,7 mm	2,7 mm	3,0 mm	3,0 mm	3,0 mm
-22°	-17°	-11°	0°	0°	0°	0°	-11°	-17°	-22°
0°	0°	+7°	0°	0°	0°	0°	+7°	0°	0°

Reposições
Replacements
5 peças / Pieces
.022"

10.14.014	10.14.012	10.14.010	10.14.009	10.14.009	10.14.009	10.14.009	10.14.011	10.14.013	10.14.015
------------------	------------------	------------------	------------------	------------------	------------------	------------------	------------------	------------------	------------------

Morelli SLP Prescrição Roth (Autoligado Passivo) com ganchos nos caninos (9°) e pré-molares



Kit 20 peças / pieces
10.13.900

Slot
.022"

Comprimento Length	
Torque Torque	
Ângulo Angle	

3,0 mm	3,0 mm	3,0mm	2,9 mm	2,9 mm	2,9 mm	2,9 mm	3,0 mm	3,0 mm	3,0 mm
-7°	-7°	-2°	+8°	+12°	+12°	+8°	-2°	-7°	-7°
0°	0°	+9°	+9°	+5°	+5°	+9°	+9°	0°	0°

Reposições
Replacements
5 peças / Pieces
.022"

10.13.007	10.13.007	10.13.005	10.13.003	10.13.001	10.13.002	10.13.004	10.13.006	10.13.008	10.13.008
------------------	------------------	------------------	------------------	------------------	------------------	------------------	------------------	------------------	------------------

Abertura do clip no sentido oclusal

Maxilar



Mandibular



Comprimento Length	
Torque Torque	
Ângulo Angle	

3,0 mm	3,0 mm	3,0 mm	2,7 mm	2,7 mm	2,7 mm	2,7 mm	3,0 mm	3,0 mm	3,0 mm
-22°	-17°	-11°	0°	0°	0°	0°	-11°	-17°	-22°
0°	0°	+7°	0°	0°	0°	0°	+7°	0°	0°

Reposições
Replacements
5 peças / Pieces
.022"

10.13.014	10.13.012	10.13.010	10.13.009	10.13.009	10.13.009	10.13.009	10.13.011	10.13.013	10.13.015
------------------	------------------	------------------	------------------	------------------	------------------	------------------	------------------	------------------	------------------

Morelli SLH Prescrição Roth (Autoligado Híbrido) com ganchos nos caninos (9°) e pré-molares



Kit 20 peças / pieces

10.23.900

Slot

.022"

Comprimento
Length

Torque
Torque

Ângulo
Angle

SLP			SLI				SLP			
3,0 mm	3,0 mm	3,0mm	2,9 mm	2,9 mm	2,9 mm	2,9 mm	3,0 mm	3,0 mm	3,0 mm	
-7°	-7°	-2°	+8°	+12°	+12°	+8°	-2°	-7°	-7°	
0°	0°	+9°	+9°	+5°	+5°	+9°	+9°	0°	0°	

Reposições
Replacements

.022"

10.13.007	10.13.007	10.13.005	10.14.003	10.14.001	10.14.002	10.14.004	10.13.006	10.13.008	10.13.008
------------------	------------------	------------------	------------------	------------------	------------------	------------------	------------------	------------------	------------------

5 peças / Pieces

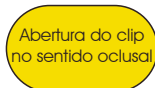

Maxilar



Mandibular

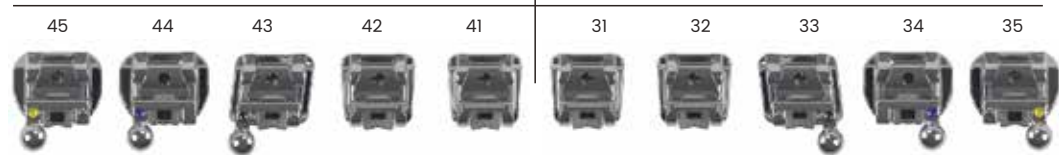

Comprimento
Length

Torque
Torque

Ângulo
Angle

SLP			SLI				SLP			
3,0 mm	3,0 mm	3,0 mm	2,7 mm	2,7 mm	2,7 mm	2,7 mm	3,0 mm	3,0 mm	3,0 mm	
-22°	-17°	-11°	0°	0°	0°	0°	-11°	-17°	-22°	
0°	0°	+7°	0°	0°	0°	0°	+7°	0°	0°	

Reposições
Replacements

.022"

10.13.014	10.13.012	10.13.010	10.14.009	10.14.009	10.14.009	10.14.009	10.13.011	10.13.013	10.13.015
------------------	------------------	------------------	------------------	------------------	------------------	------------------	------------------	------------------	------------------

5 peças / Pieces

Morelli Ceramic SLI Prescrição Roth com ganchos nos caninos (9°) e pré molares



Kit 20 peças / pieces

10.12.900

Slot

.022"

Comprimento
Length

Torque
Torque

Ângulo
Angle

3,3 mm	3,3 mm	3,3 mm	2,9 mm	3,6 mm	3,6 mm	2,9 mm	3,3 mm	3,3 mm	3,3 mm
-7°	-7°	-2°	+8°	+12°	+12°	+8°	-2°	-7°	-7°
0°	0°	+9°	+9°	+5°	+5°	+9°	+9°	0°	0°

Reposições
Replacements

.022"

10.12.007	10.12.007	10.12.005	10.12.003	10.12.001	10.12.002	10.12.004	10.12.006	10.12.008	10.12.008
------------------	------------------	------------------	------------------	------------------	------------------	------------------	------------------	------------------	------------------

2 peças / pieces

Maxilar

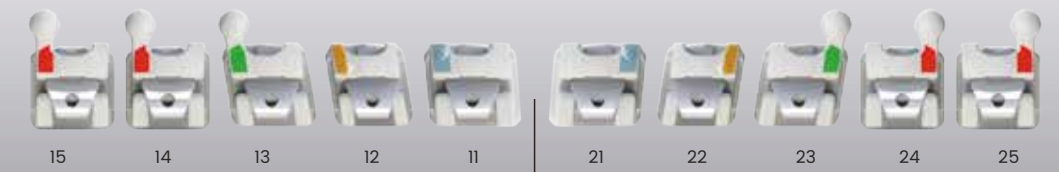

Mandibular

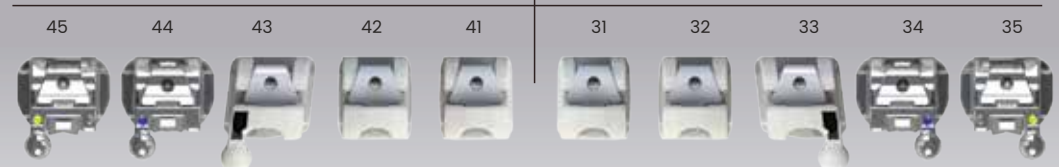

Comprimento
Length

Torque
Torque

Ângulo
Angle

3,0 mm	3,0 mm	3,3 mm	2,7 mm	2,7 mm	2,7 mm	2,7 mm	3,3 mm	3,0 mm	3,0 mm
-22°	-17°	-11°	0°	0°	0°	0°	-11°	-17°	-22°
0°	0°	+7°	0°	0°	0°	0°	+7°	0°	0°

Reposições
Replacements

.022"

10.14.014	10.14.012	10.12.011	10.12.009	10.12.009	10.12.009	10.12.009	10.12.010	10.14.013	10.14.15
------------------	------------------	------------------	------------------	------------------	------------------	------------------	------------------	------------------	-----------------

2 peças / pieces

Reposições com 2 unidades são para as peças cerâmicas e 5 unidades para as peças metálicas

Com a linha estética Morelli seus pacientes se sentirão seguros para continuar sorrindo!

poly *Safira*

MAIS
DO QUE PURA
ESTÉTICA



Ceramic



CONFORTO
ALIADO À
PERFORMANCE

Base constituída de micro cavidades com raio cérico oclusal. Ótima capacidade de adesão ao esmalte, por ser bi-jateada e silanizada.

Morelli PolySafira Prescrição Roth com ganchos nos caninos (9°) e pré molares



Kit 20 peças / pieces
10.24.900

Slot
.022"

Comprimento Length	
Torque Torque	
Ângulo Angle	

3,2 mm	3,2 mm	3,2 mm	2,9 mm	3,9 mm	3,9 mm	2,9 mm	3,2 mm	3,2 mm	3,2 mm
-7°	-7°	-2°	+8°	+12°	+12°	+8°	-2°	-7°	-7°
0°	0°	+9°	+9°	+5°	+5°	+9°	+9°	0°	0°

Reposições
Replacements
2 peças / pieces

10.24.007 10.24.007 10.24.005 10.24.003 10.24.001 10.24.002 10.24.004 10.24.006 10.24.007 10.24.007

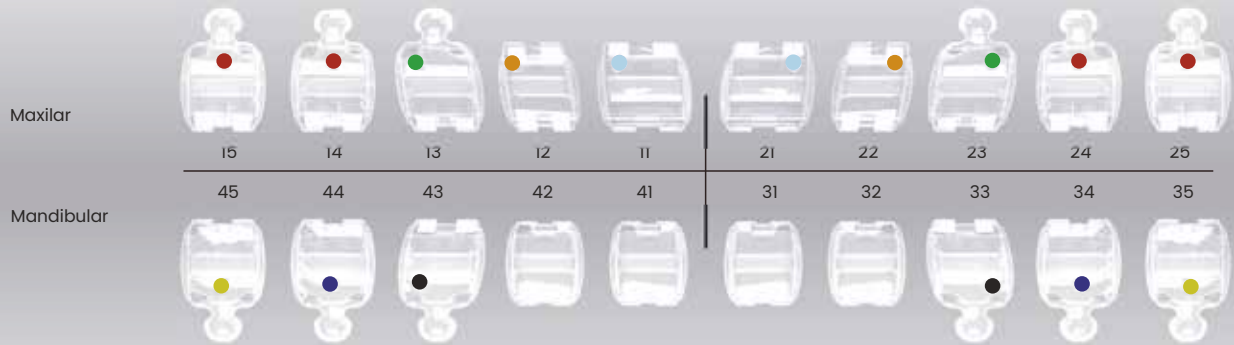

Comprimento Length	
Torque Torque	
Ângulo Angle	

3,2 mm	3,2 mm	3,2 mm	2,9 mm	2,9 mm	2,9 mm	2,9 mm	3,2 mm	3,2 mm	3,2 mm
-22°	-17°	-11°	0°	0°	0°	0°	-11°	-17°	-22°
0°	0°	+7°	0°	0°	0°	0°	+7°	0°	0°

Reposições
Replacements
2 peças / pieces

10.24.012 10.24.011 10.24.010 10.24.008 10.24.008 10.24.008 10.24.008 10.24.009 10.24.011 10.24.012

Morelli Ceramic Prescrição Roth com ganchos nos caninos (9°) e pré molares



Kit 20 peças / pieces
10.11.900

Slot
.022"

Comprimento Length	
Torque Torque	
Ângulo Angle	

3,2 mm	3,2 mm	3,2 mm	2,9 mm	3,9 mm	3,9 mm	2,9 mm	3,2 mm	3,2 mm	3,2 mm
-7°	-7°	-2°	+8°	+12°	+12°	+8°	-2°	-7°	-7°
0°	0°	+9°	+9°	+5°	+5°	+9°	+9°	0°	0°

Reposições
Replacements
5 peças / pieces

10.11.007 10.11.007 10.11.005 10.11.003 10.11.001 10.11.002 10.11.004 10.11.006 10.11.007 10.11.007



Comprimento Length	
Torque Torque	
Ângulo Angle	

3,2 mm	3,2 mm	3,2 mm	2,9 mm	2,9 mm	2,9 mm	2,9 mm	3,2 mm	3,2 mm	3,2 mm
-22°	-17°	-11°	0°	0°	0°	0°	-11°	-17°	-22°
0°	0°	+7°	0°	0°	0°	0°	+7°	0°	0°

Reposições
Replacements
5 peças / pieces

10.11.012 10.11.011 10.11.009 10.11.008 10.11.008 10.11.008 10.11.008 10.11.010 10.11.011 10.11.012

Morelli Ceramic Prescrição Edgewise com ganchos nos caninos e pré molares

Edgewise
Ceramic

Kit 20 peças / pieces
10.18.901

Slot
.022"

Comprimento
Length
Torque
Torque
Ângulo
Angle

3,2 mm	3,2 mm	3,2 mm	2,9 mm	3,6 mm	3,6 mm	2,9 mm	3,2 mm	3,2 mm	3,2 mm
0°	0°	0°	0°	0°	0°	0°	0°	0°	0°
0°	0°	0°	0°	0°	0°	0°	0°	0°	0°

Reposições
Replacements
10 peças / pieces
.022"

10.18.013	10.18.013	10.18.013	10.18.012	10.18.011	10.18.011	10.18.012	10.18.013	10.18.013	10.18.013
------------------	------------------	------------------	------------------	------------------	------------------	------------------	------------------	------------------	------------------

Maxilar

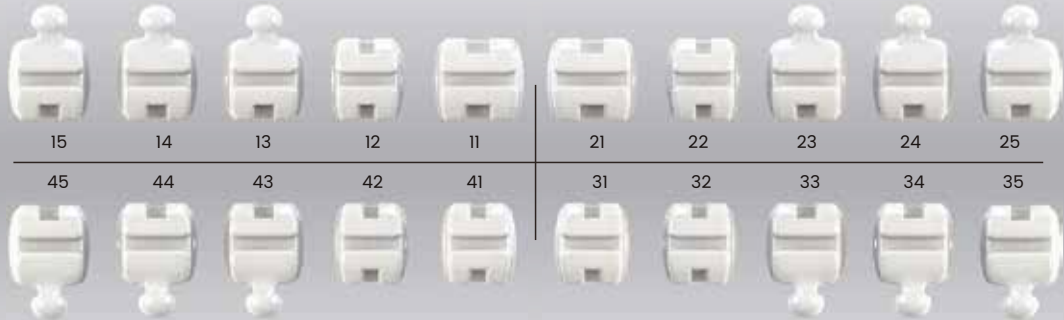

Mandibular

Comprimento
Length
Torque
Torque
Ângulo
Angle

3,2 mm	3,2 mm	3,2 mm	2,9 mm	2,9 mm	2,9 mm	2,9 mm	3,2 mm	3,2 mm	3,2 mm
0°	0°	0°	0°	0°	0°	0°	0°	0°	0°
0°	0°	0°	0°	0°	0°	0°	0°	0°	0°

Reposições
Replacements
10 peças / pieces
.022"

10.18.013	10.18.013	10.18.013	10.18.012	10.18.012	10.18.012	10.18.012	10.18.013	10.18.013	10.18.013
------------------	------------------	------------------	------------------	------------------	------------------	------------------	------------------	------------------	------------------

Morelli Composite Prescrição Roth com gancho nos caninos (13°) e pré-molares

Roth
Composite

Kit 20 peças / pieces
10.17.901

Kit 200 peças / pieces
10.17.932

Slot
.022"

Comprimento
Length
Torque
Torque
Ângulo
Angle

3,2 mm	3,2 mm	3,2 mm	2,9 mm	3,9 mm	3,9 mm	2,9 mm	3,2 mm	3,2 mm	3,2 mm
-7°	-7°	-2°	+8°	+12°	+12°	+8°	-2°	-7°	-7°
0°	0°	+13°	+9°	+5°	+5°	+9°	+13°	0°	0°

Reposições
Replacements
10 peças / pieces
.022"

10.17.007	10.17.007	10.17.005	10.17.003	10.17.001	10.17.002	10.17.004	10.17.006	10.17.008	10.17.008
------------------	------------------	------------------	------------------	------------------	------------------	------------------	------------------	------------------	------------------

Maxilar

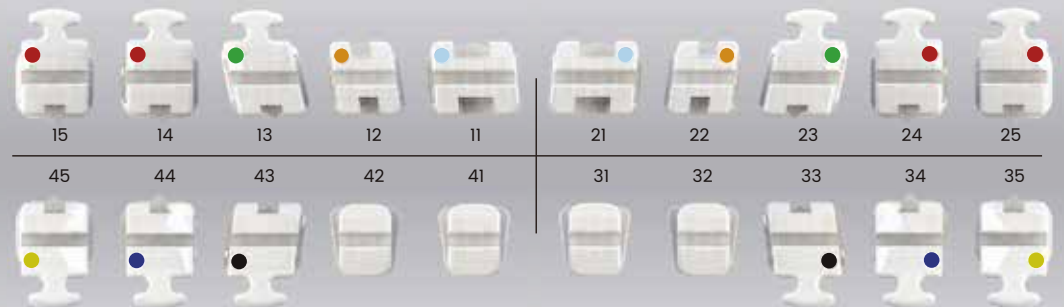

Mandibular

Comprimento
Length
Torque
Torque
Ângulo
Angle

3,2 mm	3,2 mm	3,2 mm	2,5 mm	2,5 mm	2,5 mm	2,5 mm	3,2 mm	3,2 mm	3,2 mm
-22°	-17°	-11°	0°	0°	0°	0°	-11°	-17°	-22°
0°	0°	+7°	0°	0°	0°	0°	+7°	0°	0°

Reposições
Replacements
10 peças / pieces
.022"

10.17.014	10.17.012	10.17.010	10.17.009	10.17.009	10.17.009	10.17.009	10.17.011	10.17.013	10.17.015
------------------	------------------	------------------	------------------	------------------	------------------	------------------	------------------	------------------	------------------

Morelli Max Prescrição Roth com gancho nos caninos (13°) e pré-molares

Roth Max

Kit 20 peças / pieces	Kit 200 peças / pieces	Kit 2000 peças / pieces	Slot
10.15.905	10.15.935	10.15.925	.022"
10.15.904	10.15.934	10.15.924	.018"

Comprimento Length	
Torque Torque	
Ângulo Angle	

2,9 mm	2,9 mm	2,9 mm	2,5 mm	3,2 mm	3,2 mm	2,5 mm	2,9 mm	2,9 mm	2,9 mm
-7°	-7°	-2°	+8°	+12°	+12°	+8°	-2°	-7°	-7°
0°	0°	+13°	+9°	+5°	+5°	+9°	+13°	0°	0°

Reposições Replacements	.022"
	.018"

10.15.413	10.15.413	10.15.405	10.15.402	10.15.400	10.15.401	10.15.403	10.15.407	10.15.415	10.15.415
------------------	------------------	------------------	------------------	------------------	------------------	------------------	------------------	------------------	------------------

10 peças / pieces

10.15.313	10.15.313	10.15.305	10.15.302	10.15.300	10.15.301	10.15.303	10.15.307	10.15.315	10.15.315
------------------	------------------	------------------	------------------	------------------	------------------	------------------	------------------	------------------	------------------

Maxilar

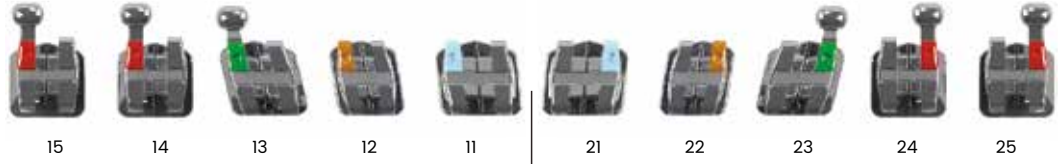

Mandibular

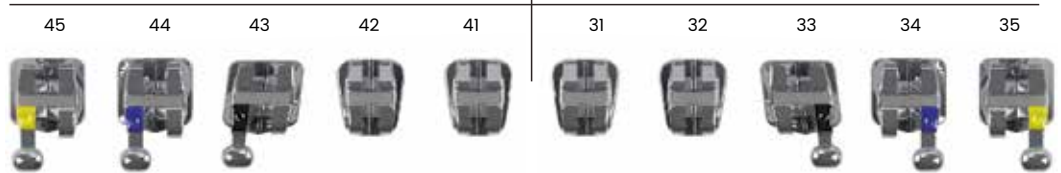

Comprimento Length	
Torque Torque	
Ângulo Angle	

2,9 mm	2,9 mm	2,9 mm	2,3 mm	2,3 mm	2,3 mm	2,3 mm	2,9 mm	2,9 mm	2,9 mm
-22°	-17°	-11°	0°	0°	0°	0°	-11°	-17°	-22°
0°	0°	+7°	0°	0°	0°	0°	+7°	0°	0°

Reposições Replacements	.022"
	.018"

10.15.426	10.15.422	10.15.418	10.15.416	10.15.416	10.15.416	10.15.416	10.15.420	10.15.424	10.15.428
------------------	------------------	------------------	------------------	------------------	------------------	------------------	------------------	------------------	------------------

10 peças / pieces

10.15.326	10.15.322	10.15.318	10.15.316	10.15.316	10.15.316	10.15.316	10.15.320	10.15.324	10.15.328
------------------	------------------	------------------	------------------	------------------	------------------	------------------	------------------	------------------	------------------

Morelli Max Prescrição Roth com ganchos nos caninos (9°) e pré-molares

Roth Max

Kit 20 peças / pieces	Kit 200 peças / pieces	Kit 2000 peças / pieces	Slot
10.15.903	10.15.933	10.15.923	.022"
10.15.902	10.15.932	10.15.922	.018"

Comprimento Length	
Torque Torque	
Ângulo Angle	

2,9 mm	2,9 mm	2,9 mm	2,5 mm	3,2mm	3,2 mm	2,5 mm	2,9 mm	2,9 mm	2,9 mm
-7°	-7°	-2°	+8°	+12°	+12°	+8°	-2°	-7°	-7°
0°	0°	+9°	+9°	+5°	+5°	+9°	+9°	0°	0°

Reposições Replacements	.022"
	.018"

10.15.413	10.15.413	10.15.409	10.15.402	10.15.400	10.15.401	10.15.403	10.15.411	10.15.415	10.15.415
------------------	------------------	------------------	------------------	------------------	------------------	------------------	------------------	------------------	------------------

10 peças / pieces

10.15.313	10.15.313	10.15.309	10.15.302	10.15.300	10.15.301	10.15.303	10.15.311	10.15.315	10.15.315
------------------	------------------	------------------	------------------	------------------	------------------	------------------	------------------	------------------	------------------

Maxilar



Mandibular

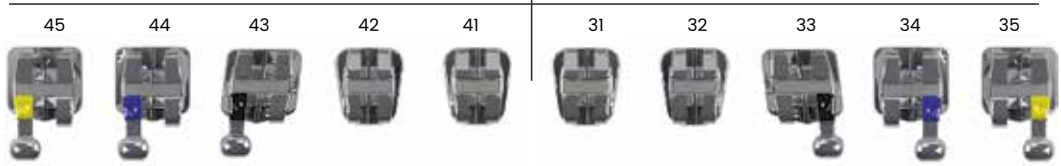

Comprimento Length	
Torque Torque	
Ângulo Angle	

2,9 mm	2,9 mm	2,9 mm	2,3 mm	2,3 mm	2,3 mm	2,3 mm	2,9 mm	2,9 mm	2,9 mm
-22°	-17°	-11°	0°	0°	0°	0°	-11°	-17°	-22°
0°	0°	+7°	0°	0°	0°	0°	+7°	0°	0°

Reposições Replacements	.022"
	.018"

10.15.426	10.15.422	10.15.418	10.15.416	10.15.416	10.15.416	10.15.416	10.15.420	10.15.424	10.15.428
------------------	------------------	------------------	------------------	------------------	------------------	------------------	------------------	------------------	------------------

10 peças / pieces

10.15.326	10.15.322	10.15.318	10.15.316	10.15.316	10.15.316	10.15.316	10.15.320	10.15.324	10.15.328
------------------	------------------	------------------	------------------	------------------	------------------	------------------	------------------	------------------	------------------

Morelli Monobloc (Níquel Free) Prescrição Roth com ganchos nos caninos (13°) e pré-molares

Roth *Monobloc*
Nickel Free

Kit 20 peças / pieces
10.15.901 Slot **.022"**

Comprimento Length	
Torque Torque	
Ângulo Angle	

2,5 mm	2,5 mm	2,7 mm	2,5 mm	3,2 mm	3,2 mm	2,5 mm	2,7 mm	2,5 mm	2,5 mm
-7°	-7°	-2°	+8°	+12°	+12°	+8°	-2°	-7°	-7°
0°	0°	+13°	+9°	+5°	+5°	+9°	+13°	0°	0°

Reposições
Replacements **.022"**
10 peças / pieces

10.15.206	10.15.206	10.15.204	10.15.202	10.15.200	10.15.201	10.15.203	10.15.205	10.15.207	10.15.207
------------------	------------------	------------------	------------------	------------------	------------------	------------------	------------------	------------------	------------------

Maxilar

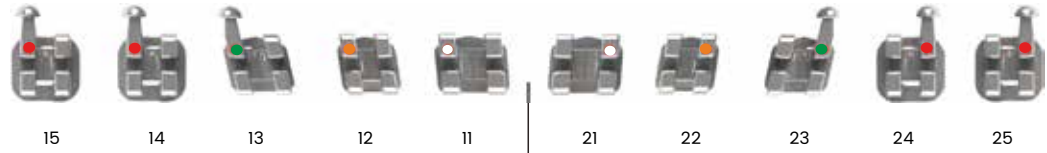

Mandibular



Comprimento Length	
Torque Torque	
Ângulo Angle	

2,5 mm	2,5 mm	2,6 mm	2,3 mm	2,3 mm	2,3 mm	2,3 mm	2,6 mm	2,5 mm	2,5 mm
-22°	-17°	-11°	0°	0°	0°	0°	-11°	-17°	-22°
0°	0°	+7°	0°	0°	0°	0°	+7°	0°	0°

Reposições
Replacements **.022"**
10 peças / pieces

10.15.214	10.15.212	10.15.210	10.15.208	10.15.208	10.15.208	10.15.208	10.15.211	10.15.213	10.15.215
------------------	------------------	------------------	------------------	------------------	------------------	------------------	------------------	------------------	------------------

Morelli Light Prescrição Roth com caninos (13°)

Roth Light

Kit 20 peças / pieces
10.10.907 Slot **.022"**
10.10.906 Slot **.018"**

Comprimento Length	
Torque Torque	
Ângulo Angle	

2,9 mm	2,9 mm	2,7mm	2,5 mm	3,2 mm	3,2 mm	2,5 mm	2,7 mm	2,9 mm	2,9 mm
-7°	-7°	-2°	+8°	+12°	+12°	+8°	-2°	-7°	-7°
0°	0°	+13°	+9°	+5°	+5°	+9°	+13°	0°	0°

Reposições
Replacements **.022"**
.018"

10.10.408	10.10.408	10.10.404	10.10.402	10.10.400	10.10.401	10.10.403	10.10.405	10.10.408	10.10.408
------------------	------------------	------------------	------------------	------------------	------------------	------------------	------------------	------------------	------------------

10.10.308	10.10.308	10.10.304	10.10.302	10.10.300	10.10.301	10.10.303	10.10.305	10.10.308	10.10.308
------------------	------------------	------------------	------------------	------------------	------------------	------------------	------------------	------------------	------------------

10 peças / pieces

Maxilar



Mandibular



Comprimento Length	
Torque Torque	
Ângulo Angle	

2,9 mm	2,9 mm	2,7 mm	2,2 mm	2,2 mm	2,2 mm	2,2 mm	2,7 mm	2,9 mm	2,9 mm
-22°	-17°	-11°	0°	0°	0°	0°	-11°	-17°	-22°
0°	0°	+7°	0°	0°	0°	0°	+7°	0°	0°

Reposições
Replacements **.022"**
.018"

10.10.416	10.10.414	10.10.412	10.10.410	10.10.410	10.10.410	10.10.410	10.10.413	10.10.414	10.10.416
------------------	------------------	------------------	------------------	------------------	------------------	------------------	------------------	------------------	------------------

10.10.316	10.10.314	10.10.312	10.10.310	10.10.310	10.10.310	10.10.310	10.10.313	10.10.314	10.10.316
------------------	------------------	------------------	------------------	------------------	------------------	------------------	------------------	------------------	------------------

10 peças / pieces

Morelli Light Prescrição Roth com caninos (9°)

Roth Light

Kit 20 peças / pieces
10.10.915

Slot
.022"

Comprimento Length	
Torque Torque	
Ângulo Angle	

2,9 mm	2,9 mm	2,7 mm	2,5 mm	3,2 mm	3,2 mm	2,5 mm	2,7 mm	2,9 mm	2,9 mm
-7°	-7°	-2°	+8°	+12°	+12°	+8°	-2°	-7°	-7°
0°	0°	+9°	+9°	+5°	+5°	+9°	+9°	0°	0°

Reposições
Replacements
.022"

10.10.408 10.10.408 10.10.406 10.10.402 10.10.400 10.10.401 10.10.403 10.10.407 10.10.408 10.10.408

10 peças / pieces

Maxilar



Mandibular



Comprimento Length	
Torque Torque	
Ângulo Angle	

2,9 mm	2,9 mm	2,7 mm	2,2 mm	2,2 mm	2,2 mm	2,2 mm	2,7 mm	2,9 mm	2,9 mm
-22°	-17°	-11°	0°	0°	0°	0°	-11°	-17°	-22°
0°	0°	+7°	0°	0°	0°	0°	+7°	0°	0°

Reposições
Replacements
.022"

10.10.416 10.10.414 10.10.412 10.10.410 10.10.410 10.10.410 10.10.410 10.10.413 10.10.414 10.10.416

10 peças / pieces

Morelli Light Prescrição Roth com ganchos nos caninos (13°)

Roth Light

Kit 20 peças / pieces
10.10.961

Slot
.022"

10.10.960

.018"

Comprimento Length	
Torque Torque	
Ângulo Angle	

2,9 mm	2,9 mm	2,7mm	2,5 mm	3,2 mm	3,2 mm	2,5 mm	2,7 mm	2,9 mm	2,9 mm
-7°	-7°	-2°	+8°	+12°	+12°	+8°	-2°	-7°	-7°
0°	0°	+13°	+9°	+5°	+5°	+9°	+13°	0°	0°

Reposições
Replacements
.022"

10.10.408 10.10.408 10.10.420 10.10.402 10.10.400 10.10.401 10.10.403 10.10.421 10.10.408 10.10.408

10 peças / pieces

Maxilar



Mandibular



Comprimento Length	
Torque Torque	
Ângulo Angle	

2,9 mm	2,9 mm	2,7 mm	2,2 mm	2,2 mm	2,2 mm	2,2 mm	2,7 mm	2,9 mm	2,9 mm
-22°	-17°	-11°	0°	0°	0°	0°	-11°	-17°	-22°
0°	0°	+7°	0°	0°	0°	0°	+7°	0°	0°

Reposições
Replacements
.022"

10.10.416 10.10.414 10.10.426 10.10.410 10.10.410 10.10.410 10.10.410 10.10.427 10.10.414 10.10.416

10 peças / pieces

10.10.316 10.10.314 10.10.326 10.10.310 10.10.310 10.10.310 10.10.310 10.10.327 10.10.314 10.10.316

Morelli Light Prescrição Roth com ganchos nos caninos (9°)

Kit 20 peças / pieces
10.10.963

Slot
.022"

Roth Light

Comprimento Length	
Torque Torque	
Ângulo Angle	

2,9 mm	2,9 mm	2,7 mm	2,5 mm	3,2 mm	3,2 mm	2,5 mm	2,7 mm	2,9 mm	2,9 mm
-7°	-7°	-2°	+8°	+12°	+12°	+8°	-2°	-7°	-7°
0°	0°	+9°	+9°	+5°	+5°	+9°	+9°	0°	0°

Reposições
Replacements
.022"

10.10.408 10.10.408 10.10.422 10.10.402 10.10.400 10.10.401 10.10.403 10.10.423 10.10.408 10.10.408

10 peças / pieces

Maxilar



Mandibular



Comprimento Length	
Torque Torque	
Ângulo Angle	

2,9 mm	2,9 mm	2,7 mm	2,2 mm	2,2 mm	2,2 mm	2,2 mm	2,7 mm	2,9 mm	2,9 mm
-22°	-17°	-11°	0°	0°	0°	0°	-11°	-17°	-22°
0°	0°	+7°	0°	0°	0°	0°	+7°	0°	0°

Reposições
Replacements
.022"

10.10.416 10.10.414 10.10.426 10.10.410 10.10.410 10.10.410 10.10.410 10.10.427 10.10.414 10.10.416

10 peças / pieces

Morelli Light Prescrição Roth com ganchos nos caninos (13°) e pré-molares

Kit 20 peças / pieces
10.10.979

Kit 200 peças / pieces
10.10.996

Slot
.022"

Roth Light

10.10.978

.018"

Comprimento Length	
Torque Torque	
Ângulo Angle	

2,9 mm	2,9 mm	2,7 mm	2,5 mm	3,2 mm	3,2 mm	2,5 mm	2,7 mm	2,9 mm	2,9 mm
-7°	-7°	-2°	+8°	+12°	+12°	+8°	-2°	-7°	-7°
0°	0°	+13°	+9°	+5°	+5°	+9°	+13°	0°	0°

Reposições
Replacements
.022"

10.10.424 10.10.424 10.10.420 10.10.402 10.10.400 10.10.401 10.10.403 10.10.421 10.10.425 10.10.425

10 peças / pieces

Maxilar



Mandibular



Comprimento Length	
Torque Torque	
Ângulo Angle	

2,9 mm	2,9 mm	2,7 mm	2,2 mm	2,2 mm	2,2 mm	2,2 mm	2,7 mm	2,9 mm	2,9 mm
-22°	-17°	-11°	0°	0°	0°	0°	-11°	-17°	-22°
0°	0°	+7°	0°	0°	0°	0°	+7°	0°	0°

Reposições
Replacements
.022"

10.10.430 10.10.428 10.10.426 10.10.410 10.10.410 10.10.410 10.10.410 10.10.427 10.10.429 10.10.431

10 peças / pieces

10.10.330 10.10.328 10.10.326 10.10.310 10.10.310 10.10.310 10.10.310 10.10.327 10.10.329 10.10.331

Morelli Light Prescrição Roth com ganchos nos caninos (9°) e pré-molares

Kit 20 peças / pieces **10.10.981** Slot **.022"**
 Kit 200 peças / pieces **10.10.997**

Roth Light

Comprimento Length
 Torque Torque
 Ângulo Angle

2,9 mm	2,9 mm	2,7 mm	2,5 mm	3,2 mm	3,2 mm	2,5 mm	2,7 mm	2,9 mm	2,9 mm
-7°	-7°	-2°	+8°	+12°	+12°	+8°	-2°	-7°	-7°
0°	0°	+9°	+9°	+5°	+5°	+9°	+9°	0°	0°

Reposições Replacements **.022"**
 10 peças / pieces

10.10.424 **10.10.424** **10.10.422** **10.10.402** **10.10.400** **10.10.401** **10.10.403** **10.10.423** **10.10.425** **10.10.425**

Maxilar



Mandibular



Comprimento Length
 Torque Torque
 Ângulo Angle

2,9 mm	2,9 mm	2,7 mm	2,2 mm	2,2 mm	2,2 mm	2,2 mm	2,7 mm	2,9 mm	2,9 mm
-22°	-17°	-11°	0°	0°	0°	0°	-11°	-17°	-22°
0°	0°	+7°	0°	0°	0°	0°	+7°	0°	0°

Reposições Replacements **.022"**
 10 peças / pieces

10.10.430 **10.10.428** **10.10.426** **10.10.410** **10.10.410** **10.10.410** **10.10.410** **10.10.427** **10.10.429** **10.10.431**

Morelli Light Prescrição Biofuncional classe III com ganchos nos caninos (13°) e pré-molares

Kit 20 peças / pieces **10.10.920** Slot **.022"**

Roth Light

Comprimento Length
 Torque Torque
 Ângulo Angle

2,9 mm	2,9 mm	2,7 mm	2,5 mm	3,2 mm	3,2 mm	2,5 mm	2,7 mm	2,9 mm	2,9 mm
-7°	-7°	-2°	0°	0°	0°	0°	-2°	-7°	-7°
0°	0°	+13°	+9°	+5°	+5°	+9°	+13°	0°	0°

Reposições Replacements **.022"**
 10 peças / pieces

10.10.424 **10.10.424** **10.10.420** **10.10.436** **10.10.434** **10.10.435** **10.10.437** **10.10.421** **10.10.425** **10.10.425**

Maxilar

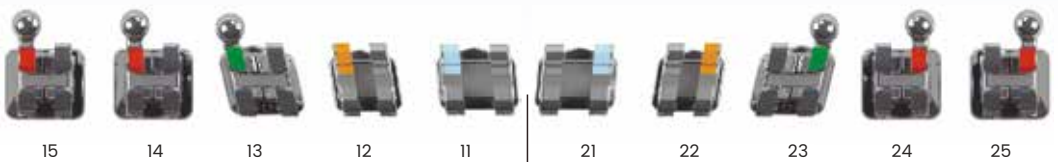

Mandibular

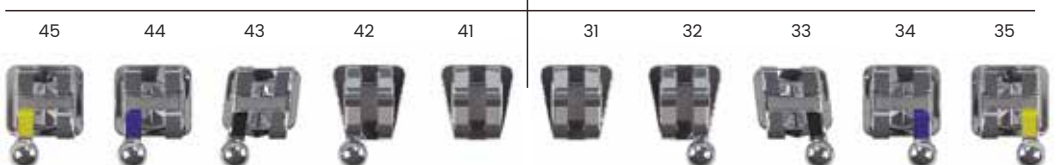

Comprimento Length
 Torque Torque
 Ângulo Angle

2,9 mm	2,9 mm	2,7 mm	2,2 mm	2,2 mm	2,2 mm	2,2 mm	2,7 mm	2,9 mm	2,9 mm
-22°	-17°	-11°	+10°	+10°	+10°	+10°	-11°	-17°	-22°
0°	0°	+7°	0°	0°	0°	0°	+7°	0°	0°

Reposições Replacements **.022"**
 10 peças / pieces

10.10.430 **10.10.428** **10.10.426** **10.10.432** **10.10.438** **10.10.438** **10.10.433** **10.10.427** **10.10.429** **10.10.431**

Morelli Standard Prescrição Roth com caninos (13°)

Kit 20 peças / pieces

10.10.901

10.10.900

Slot

.022"

.018"

Roth Standard

Comprimento Length	
Torque Torque	
Ângulo Angle	

3,2 mm	3,2 mm	3,2 mm	2,9 mm	3,9 mm	3,9 mm	2,9 mm	3,2 mm	3,2 mm	3,2 mm
-7°	-7°	-2°	+8°	+12°	+12°	+8°	-2°	-7°	-7°
0°	0°	+13°	+9°	+5°	+5°	+9°	+13°	0°	0°

Reposições
Replacements

.022"

.018"

10.10.208	10.10.208	10.10.204	10.10.202	10.10.200	10.10.201	10.10.203	10.10.205	10.10.208	10.10.208
------------------	------------------	------------------	------------------	------------------	------------------	------------------	------------------	------------------	------------------

10.10.108	10.10.108	10.10.104	10.10.102	10.10.100	10.10.101	10.10.103	10.10.105	10.10.108	10.10.108
------------------	------------------	------------------	------------------	------------------	------------------	------------------	------------------	------------------	------------------

10 peças / pieces

Maxilar

15	14	13	12	11	21	22	23	24	25

Mandibular

45	44	43	42	41	31	32	33	34	35

Comprimento Length	
Torque Torque	
Ângulo Angle	

3,2 mm	3,2 mm	3,2 mm	2,2 mm	2,2 mm	2,2 mm	2,2 mm	3,2 mm	3,2 mm	3,2 mm
-22°	-17°	-11°	0°	0°	0°	0°	-11°	-17°	-22°
0°	0°	+7°	0°	0°	0°	0°	+7°	0°	0°

Reposições
Replacements

.022"

.018"

10.10.216	10.10.214	10.10.212	10.10.410	10.10.410	10.10.410	10.10.410	10.10.213	10.10.214	10.10.216
------------------	------------------	------------------	------------------	------------------	------------------	------------------	------------------	------------------	------------------

10.10.116	10.10.114	10.10.112	10.10.310	10.10.310	10.10.310	10.10.310	10.10.113	10.10.114	10.10.116
------------------	------------------	------------------	------------------	------------------	------------------	------------------	------------------	------------------	------------------

10 peças / pieces

Morelli Standard Prescrição Roth com caninos (9°)

Kit 20 peças / pieces

10.10.911

Slot

.022"

Roth Standard

Comprimento Length	
Torque Torque	
Ângulo Angle	

3,2 mm	3,2 mm	3,2 mm	2,9 mm	3,9 mm	3,9 mm	2,9 mm	3,2 mm	3,2 mm	3,2 mm
-7°	-7°	-2°	+8°	+12°	+12°	+8°	-2°	-7°	-7°
0°	0°	+9°	+9°	+5°	+5°	+9°	+9°	0°	0°

Reposições
Replacements

.022"

10 peças / pieces

10.10.208	10.10.208	10.10.206	10.10.202	10.10.200	10.10.201	10.10.203	10.10.207	10.10.208	10.10.208
------------------	------------------	------------------	------------------	------------------	------------------	------------------	------------------	------------------	------------------

Maxilar

15	14	13	12	11	21	22	23	24	25

Mandibular

45	44	43	42	41	31	32	33	34	35

Comprimento Length	
Torque Torque	
Ângulo Angle	

3,2 mm	3,2 mm	3,2 mm	2,2 mm	2,2 mm	2,2 mm	2,2 mm	3,2 mm	3,2 mm	3,2 mm
-22°	-17°	-11°	0°	0°	0°	0°	-11°	-17°	-22°
0°	0°	+7°	0°	0°	0°	0°	+7°	0°	0°

Reposições
Replacements

.022"

10 peças / pieces

10.10.216	10.10.214	10.10.212	10.10.410	10.10.410	10.10.410	10.10.410	10.10.213	10.10.214	10.10.216
------------------	------------------	------------------	------------------	------------------	------------------	------------------	------------------	------------------	------------------

Morelli Standard Prescrição Roth com gancho nos caninos (13°)

Kit 20 peças / pieces

10.10.951

10.10.950

Slot

.022"

.018"

Roth Standard

Comprimento Length	
Torque	
Ângulo Angle	

3,2 mm	3,2 mm	3,2 mm	2,9 mm	3,9 mm	3,9 mm	2,9 mm	3,2 mm	3,2 mm	3,2 mm
-7°	-7°	-2°	+8°	+12°	+12°	+8°	-2°	-7°	-7°
0°	0°	+13°	+9°	+5°	+5°	+9°	+13°	0°	0°

Reposições Replacements	.022"
	.018"

10.10.208	10.10.208	10.10.220	10.10.202	10.10.200	10.10.201	10.10.203	10.10.221	10.10.208	10.10.208
------------------	------------------	------------------	------------------	------------------	------------------	------------------	------------------	------------------	------------------

10.10.108	10.10.108	10.10.120	10.10.102	10.10.100	10.10.101	10.10.103	10.10.121	10.10.108	10.10.108
------------------	------------------	------------------	------------------	------------------	------------------	------------------	------------------	------------------	------------------

10 peças / pieces

Maxilar

15	14	13	12	11	21	22	23	24	25

Mandibular

45	44	43	42	41	31	32	33	34	35

Comprimento Length	
Torque	
Ângulo Angle	

3,2 mm	3,2 mm	3,2 mm	2,2 mm	2,2 mm	2,2 mm	2,2 mm	3,2 mm	3,2 mm	3,2 mm
-22°	-17°	-11°	0°	0°	0°	0°	-11°	-17°	-22°
0°	0°	+7°	0°	0°	0°	0°	+7°	0°	0°

Reposições Replacements	.022"
	.018"

10.10.216	10.10.214	10.10.226	10.10.410	10.10.410	10.10.410	10.10.410	10.10.227	10.10.214	10.10.216
------------------	------------------	------------------	------------------	------------------	------------------	------------------	------------------	------------------	------------------

10.10.116	10.10.114	10.10.126	10.10.310	10.10.310	10.10.310	10.10.310	10.10.127	10.10.114	10.10.116
------------------	------------------	------------------	------------------	------------------	------------------	------------------	------------------	------------------	------------------

10 peças / pieces

Morelli Standard Prescrição Roth com ganchos nos caninos (9°)

Kit 20 peças / pieces

10.10.953

Slot

.022"

Roth Standard

Comprimento Length	
Torque	
Ângulo Angle	

3,2 mm	3,2 mm	3,2 mm	2,9 mm	3,9 mm	3,9 mm	2,9 mm	3,2 mm	3,2 mm	3,2 mm
-7°	-7°	-2°	+8°	+12°	+12°	+8°	-2°	-7°	-7°
0°	0°	+9°	+9°	+5°	+5°	+9°	+9°	0°	0°

Reposições Replacements	.022"
----------------------------	--------------

10.10.208	10.10.208	10.10.222	10.10.202	10.10.200	10.10.201	10.10.203	10.10.223	10.10.208	10.10.208
------------------	------------------	------------------	------------------	------------------	------------------	------------------	------------------	------------------	------------------

10 peças / pieces

Maxilar

15	14	13	12	11	21	22	23	24	25

Mandibular

45	44	43	42	41	31	32	33	34	35

Comprimento Length	
Torque	
Ângulo Angle	

3,2 mm	3,2 mm	3,2 mm	2,2 mm	2,2 mm	2,2 mm	2,2 mm	3,2 mm	3,2 mm	3,2 mm
-22°	-17°	-11°	0°	0°	0°	0°	-11°	-17°	-22°
0°	0°	+7°	0°	0°	0°	0°	+7°	0°	0°

Reposições Replacements	.022"
----------------------------	--------------

10.10.216	10.10.214	10.10.226	10.10.410	10.10.410	10.10.410	10.10.410	10.10.227	10.10.214	10.10.216
------------------	------------------	------------------	------------------	------------------	------------------	------------------	------------------	------------------	------------------

10 peças / pieces

Morelli Standard Prescrição Roth com gancho nos caninos (13°) e pré-molares

Roth Standard

Kit 20 peças / pieces
10.10.969

Slot
.022"

Comprimento Length	
Torque Torque	
Ângulo Angle	

3,2 mm	3,2 mm	3,2 mm	2,9 mm	3,9 mm	3,9 mm	2,9 mm	3,2 mm	3,2 mm	3,2 mm
-7°	-7°	-2°	+8°	+12°	+12°	+8°	-2°	-7°	-7°
0°	0°	+13°	+9°	+5°	+5°	+9°	+13°	0°	0°

Reposições
Replacements
.022"

10.10.224	10.10.224	10.10.220	10.10.202	10.10.200	10.10.201	10.10.203	10.10.221	10.10.225	10.10.225
------------------	------------------	------------------	------------------	------------------	------------------	------------------	------------------	------------------	------------------

10 peças / pieces

Maxilar

15	14	13	12	11	21	22	23	24	25

Mandibular

45	44	43	42	41	31	32	33	34	35

Comprimento Length	
Torque Torque	
Ângulo Angle	

3,2 mm	3,2 mm	3,2 mm	2,2 mm	2,2 mm	2,2 mm	2,2 mm	3,2 mm	3,2 mm	3,2 mm
-22°	-17°	-11°	0°	0°	0°	0°	-11°	-17°	-22°
0°	0°	+7°	0°	0°	0°	0°	+7°	0°	0°

Reposições
Replacements
.022"

10.10.230	10.10.228	10.10.226	10.10.410	10.10.410	10.10.410	10.10.410	10.10.227	10.10.229	10.10.231
------------------	------------------	------------------	------------------	------------------	------------------	------------------	------------------	------------------	------------------

10 peças / pieces

Morelli Standard Prescrição Roth com ganchos nos caninos (9°) e pré-molares

Roth Standard

Kit 20 peças / pieces
10.10.971

Slot
.022"

Comprimento Length	
Torque Torque	
Ângulo Angle	

3,2 mm	3,2 mm	3,2 mm	2,9 mm	3,9 mm	3,9 mm	2,9 mm	3,2 mm	3,2 mm	3,2 mm
-7°	-7°	-2°	+8°	+12°	+12°	+8°	-2°	-7°	-7°
0°	0°	+9°	+9°	+5°	+5°	+9°	+9°	0°	0°

Reposições
Replacements
.022"

10.10.224	10.10.224	10.10.222	10.10.202	10.10.200	10.10.201	10.10.203	10.10.223	10.10.225	10.10.225
------------------	------------------	------------------	------------------	------------------	------------------	------------------	------------------	------------------	------------------

10 peças / pieces

Maxilar

15	14	13	12	11	21	22	23	24	25

Mandibular

45	44	43	42	41	31	32	33	34	35

Comprimento Length	
Torque Torque	
Ângulo Angle	

3,2 mm	3,2 mm	3,2 mm	2,2 mm	2,2 mm	2,2 mm	2,2 mm	3,2 mm	3,2 mm	3,2 mm
-22°	-17°	-11°	0°	0°	0°	0°	-11°	-17°	-22°
0°	0°	+7°	0°	0°	0°	0°	+7°	0°	0°

Reposições
Replacements
.022"

10.10.230	10.10.228	10.10.226	10.10.410	10.10.410	10.10.410	10.10.410	10.10.227	10.10.229	10.10.231
------------------	------------------	------------------	------------------	------------------	------------------	------------------	------------------	------------------	------------------

10 peças / pieces

Morelli Nano Prescrição Roth com gancho nos caninos (9°) e pré-molares

Roth nano

Kit 20 peças / pieces

10.15.906

Slot

.022"

Comprimento Length	
Torque Torque	
Ângulo Angle	

2,5 mm	2,5 mm	2,6 mm	2,5 mm	3,2 mm	3,2 mm	2,5 mm	2,6 mm	2,5 mm	2,5 mm
-7°	-7°	-2°	+8°	+12°	+12°	+8°	-2°	-7°	-7°
0°	0°	+9°	+9°	+5°	+5°	+9°	+9°	0°	0°

Reposições
Replacements

.022"

10.15.509	10.15.509	10.15.505	10.15.503	10.15.501	10.15.502	10.15.504	10.15.506	10.15.510	10.15.510
------------------	------------------	------------------	------------------	------------------	------------------	------------------	------------------	------------------	------------------

10 peças / pieces

Maxilar



15	14	13	12	11	21	22	23	24	25
45	44	43	42	41	31	32	33	34	35

Mandibular



Comprimento Length	
Torque Torque	
Ângulo Angle	

2,5 mm	2,5 mm	2,6 mm	2,2 mm	2,2 mm	2,2 mm	2,2 mm	2,6 mm	2,5 mm	2,5 mm
-22°	-17°	-11°	0°	0°	0°	0°	-11°	-17°	-22°
0°	0°	+7°	0°	0°	0°	0°	+7°	0°	0°

Reposições
Replacements

.022"

10.15.516	10.15.514	10.15.512	10.15.511	10.15.511	10.15.511	10.15.511	10.15.513	10.15.515	10.15.517
------------------	------------------	------------------	------------------	------------------	------------------	------------------	------------------	------------------	------------------

10 peças / pieces

Morelli Max Bidimensional Prescrição Roth com gancho nos caninos (9°) e pré-molares

Roth Bidimensional

Kit 20 peças / pieces

10.15.930

Slot

.022"

.018"

Comprimento Length	
Torque Torque	
Ângulo Angle	

2,9 mm	2,9 mm	2,9 mm	2,5 mm	3,2 mm	3,2 mm	2,5 mm	2,9 mm	2,9 mm	2,9 mm
-7°	-7°	-2°	+8°	+12°	+12°	+8°	-2°	-7°	-7°
0°	0°	+9°	+9°	+5°	+5°	+9°	+9°	0°	0°

Reposições
Replacements

.022"

10.15.413	10.15.413	10.15.409	10.15.302	10.15.300	10.15.301	10.15.303	10.15.411	10.15.415	10.15.415
------------------	------------------	------------------	------------------	------------------	------------------	------------------	------------------	------------------	------------------

Reposições
Replacements

.018"

10 peças / pieces

Maxilar



15	14	13	12	11	21	22	23	24	25
45	44	43	42	41	31	32	33	34	35

Mandibular



Comprimento Length	
Torque Torque	
Ângulo Angle	

2,9 mm	2,9 mm	2,9 mm	2,3 mm	2,3 mm	2,3 mm	2,3 mm	2,9 mm	2,9 mm	2,9 mm
-22°	-17°	-11°	0°	0°	0°	0°	-11°	-17°	-22°
0°	0°	+7°	0°	0°	0°	0°	+7°	0°	0°

Reposições
Replacements

.022"

10.15.426	10.15.422	10.15.418	10.15.316	10.15.316	10.15.316	10.15.316	10.15.420	10.15.424	10.15.428
------------------	------------------	------------------	------------------	------------------	------------------	------------------	------------------	------------------	------------------

Reposições
Replacements

.018"

10 peças / pieces



Morelli Max Prescrição M.B.T. com gancho nos pré-molares

M.B.T. Max

Kit 20 peças / pieces **10.35.906** Kit 200 peças / pieces **10.35.936** Slot **.022"**

Comprimento Length	
Torque Torque	
Ângulo Angle	

2,9 mm	2,9 mm	2,9 mm	2,5 mm	3,2 mm	3,2 mm	2,5 mm	2,9 mm	2,9 mm	2,9 mm
-7°	-7°	-7°	+10°	+17°	+17°	+10°	-7°	-7°	-7°
0°	0°	+8°	+8°	+4°	+4°	+8°	+8°	0°	0°

Reposições
Replacements **.022"**

10.35.109 **10.35.109** **10.35.105** **10.35.103** **10.35.101** **10.35.102** **10.35.104** **10.35.106** **10.35.110** **10.35.110**

10 peças / pieces

Maxilar

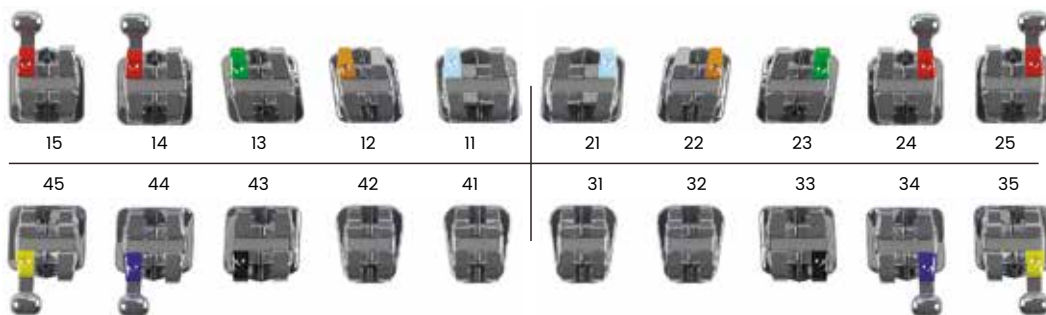

Mandibular

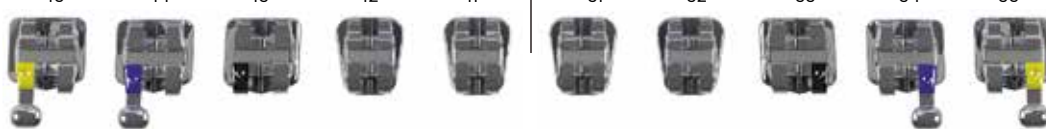

Comprimento Length	
Torque Torque	
Ângulo Angle	

2,9 mm	2,9 mm	2,9 mm	2,3 mm	2,3 mm	2,3 mm	2,3 mm	2,9 mm	2,9 mm	2,9 mm
-17°	-12°	-6°	-6°	-6°	-6°	-6°	-6°	-12°	-17°
+2°	+2°	+3°	0°	0°	0°	0°	+3°	+2°	+2°

Reposições
Replacements **.022"**

10.35.118 **10.35.116** **10.35.112** **10.35.111** **10.35.111** **10.35.111** **10.35.111** **10.35.113** **10.35.117** **10.35.119**

10 peças / pieces

Morelli Max Prescrição M.B.T. com gancho nos caninos e pré-molares

M.B.T. Max

Kit 20 peças / pieces **10.35.905** Kit 200 peças / pieces **10.35.935** Slot **.022"**

Comprimento Length	
Torque Torque	
Ângulo Angle	

2,9 mm	2,9 mm	2,9 mm	2,5 mm	3,2 mm	3,2 mm	2,5 mm	2,9 mm	2,9 mm	2,9 mm
-7°	-7°	0°	+10°	+17°	+17°	+10°	0°	-7°	-7°
0°	0°	+8°	+8°	+4°	+4°	+8°	+8°	0°	0°

Reposições
Replacements **.022"**

10.35.109 **10.35.109** **10.35.107** **10.35.103** **10.35.101** **10.35.102** **10.35.104** **10.35.108** **10.35.110** **10.35.110**

10 peças / pieces

Maxilar



Mandibular

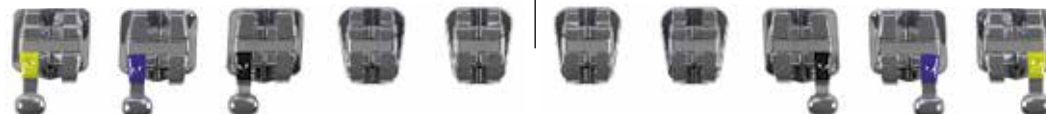

Comprimento Length	
Torque Torque	
Ângulo Angle	

2,9 mm	2,9 mm	2,9 mm	2,3 mm	2,3 mm	2,3 mm	2,3 mm	2,9 mm	2,9 mm	2,9 mm
-17°	-12°	0°	-6°	-6°	-6°	-6°	0°	-12°	-17°
+2°	+2°	+3°	0°	0°	0°	0°	+3°	+2°	+2°

Reposições
Replacements **.022"**

10.35.118 **10.35.116** **10.35.114** **10.35.111** **10.35.111** **10.35.111** **10.35.111** **10.35.115** **10.35.117** **10.35.119**

10 peças / pieces

Morelli Standard Prescrição M.B.T.

Kit 20 peças / pieces
10.35.901

Slot
.022"

M.B.T. Standard

Comprimento Length	
Torque Torque	
Ângulo Angle	

3,2 mm	3,2 mm	3,2 mm	2,9 mm	3,9 mm	3,9 mm	2,9 mm	3,2 mm	3,2 mm	3,2 mm
-7°	-7°	-7°	+10°	+17°	+17°	+10°	-7°	-7°	-7°
0°	0°	+8°	+8°	+4°	+4°	+8°	+8°	0°	0°

Reposições
Replacements **.022"**

10.35.007	10.35.007	10.35.005	10.35.003	10.35.001	10.35.002	10.35.004	10.35.006	10.35.007	10.35.007
------------------	------------------	------------------	------------------	------------------	------------------	------------------	------------------	------------------	------------------

10 peças / pieces

Maxilar



Mandibular



Comprimento Length	
Torque Torque	
Ângulo Angle	

3,2 mm	3,2 mm	3,2 mm	2,2 mm	2,2 mm	2,2 mm	2,2 mm	3,2 mm	3,2 mm	3,2 mm
-17°	-12°	-6°	-6°	-6°	-6°	-6°	-6°	-12°	-17°
+2°	+2°	+3°	0°	0°	0°	0°	+3°	+2°	+2°

Reposições
Replacements **.022"**

10.35.015	10.35.013	10.35.011	10.35.111	10.35.111	10.35.111	10.35.111	10.35.012	10.35.014	10.35.016
------------------	------------------	------------------	------------------	------------------	------------------	------------------	------------------	------------------	------------------

10 peças / pieces

Morelli Standard Prescrição M.B.T. com gancho nos caninos

Kit 20 peças / pieces
10.35.902

Slot
.022"

M.B.T. Standard

Comprimento Length	
Torque Torque	
Ângulo Angle	

3,2 mm	3,2 mm	3,2 mm	2,9 mm	3,9 mm	3,9 mm	2,9 mm	3,2 mm	3,2 mm	3,2 mm
-7°	-7°	0°	+10°	+17°	+17°	+10°	0°	-7°	-7°
0°	0°	+8°	+8°	+4°	+4°	+8°	+8°	0°	0°

Reposições
Replacements **.022"**

10.35.007	10.35.007	10.35.017	10.35.003	10.35.001	10.35.002	10.35.004	10.35.018	10.35.007	10.35.007
------------------	------------------	------------------	------------------	------------------	------------------	------------------	------------------	------------------	------------------

10 peças / pieces

Maxilar



Mandibular

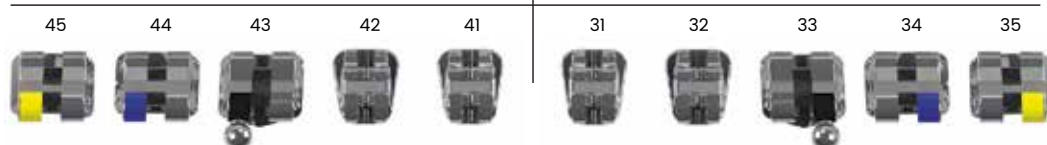

Comprimento Length	
Torque Torque	
Ângulo Angle	

3,2 mm	3,2 mm	3,2 mm	2,2 mm	2,2 mm	2,2 mm	2,2 mm	3,2 mm	3,2 mm	3,2 mm
-17°	-12°	0°	-6°	-6°	-6°	-6°	0°	-12°	-17°
+2°	+2°	+3°	0°	0°	0°	0°	+3°	+2°	+2°

Reposições
Replacements **.022"**

10.35.015	10.35.013	10.35.019	10.35.111	10.35.111	10.35.111	10.35.111	10.35.020	10.35.014	10.35.016
------------------	------------------	------------------	------------------	------------------	------------------	------------------	------------------	------------------	------------------

10 peças / pieces

Morelli Light Prescrição M.B.T.

Kit 20 peças / pieces
10.35.904

Slot
.022"

M.B.T. Light

Comprimento Length	
Torque Torque	
Ângulo Angle	

3,2 mm	3,2 mm	2,7 mm	2,5 mm	3,2 mm	3,2 mm	2,5 mm	2,7 mm	3,2 mm	3,2 mm
-7°	-7°	-7°	+10°	+17°	+17°	+10°	-7°	-7°	-7°
0°	0°	+8°	+8°	+4°	+4°	+8°	+8°	0°	0°

Reposições
Replacements **.022"**

10.35.007	10.35.007	10.35.030	10.35.103	10.35.101	10.35.102	10.35.104	10.35.031	10.35.007	10.35.007
------------------	------------------	------------------	------------------	------------------	------------------	------------------	------------------	------------------	------------------

10 peças / pieces

Maxilar



Mandibular

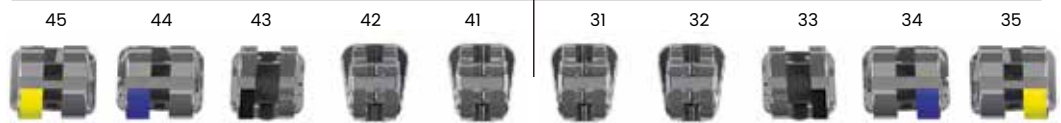

Comprimento Length	
Torque Torque	
Ângulo Angle	

3,2 mm	3,2 mm	2,7 mm	2,3 mm	2,3 mm	2,3 mm	2,3 mm	2,7 mm	3,2 mm	3,2 mm
-17°	-12°	-6°	-6°	-6°	-6°	-6°	-6°	-12°	-17°
+2°	+2°	+3°	0°	0°	0°	0°	+3°	+2°	+2°

Reposições
Replacements **.022"**

10.35.015	10.35.013	10.35.032	10.35.111	10.35.111	10.35.111	10.35.111	10.35.033	10.35.014	10.35.016
------------------	------------------	------------------	------------------	------------------	------------------	------------------	------------------	------------------	------------------

10 peças / pieces

Morelli Light Prescrição M.B.T. com gancho nos caninos e pré-molares

Kit 20 peças / pieces
10.35.903

Slot
.022"

M.B.T. Light

Comprimento Length	
Torque Torque	
Ângulo Angle	

3,2 mm	3,2 mm	2,7 mm	2,5 mm	3,2 mm	3,2 mm	2,5 mm	2,7 mm	3,2 mm	3,2 mm
-7°	-7°	0°	+10°	+17°	+17°	+10°	0°	-7°	-7°
0°	0°	+8°	+8°	+4°	+4°	+8°	+8°	0°	0°

Reposições
Replacements **.022"**

10.35.034	10.35.034	10.35.025	10.35.103	10.35.101	10.35.102	10.35.104	10.35.026	10.35.035	10.35.035
------------------	------------------	------------------	------------------	------------------	------------------	------------------	------------------	------------------	------------------

10 peças / pieces

Maxilar



Mandibular

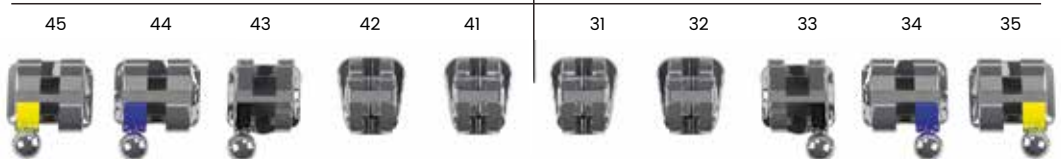

Comprimento Length	
Torque Torque	
Ângulo Angle	

3,2 mm	3,2 mm	2,7 mm	2,3 mm	2,3 mm	2,3 mm	2,3 mm	2,7 mm	3,2 mm	3,2 mm
-17°	-12°	0°	-6°	-6°	-6°	-6°	0°	-12°	-17°
+2°	+2°	+3°	0°	0°	0°	0°	+3°	+2°	+2°

Reposições
Replacements **.022"**

10.35.038	10.35.036	10.35.028	10.35.111	10.35.111	10.35.111	10.35.111	10.35.029	10.35.037	10.35.039
------------------	------------------	------------------	------------------	------------------	------------------	------------------	------------------	------------------	------------------

10 peças / pieces

Morelli Max Prescrição Capelozza Padrão I com ganchos nos caninos e pré-molares

Kit 20 peças / pieces **10.19.904** Kit 200 peças / pieces **10.19.934** Slot **.022"**

Prescrição Capelozza *Max*

Comprimento Length	
Torque Torque	
Ângulo Angle	

2,9 mm	2,9 mm	2,9 mm	2,5 mm	3,2 mm	3,2 mm	2,5 mm	2,9 mm	2,9 mm	2,9 mm
-7°	-7°	-5°	+3°	+7°	+7°	+3°	-5°	-7°	-7°
0°	0°	+8°	+9°	+5°	+5°	+9°	+8°	0°	0°

Reposições
Replacements **.022"**
10 peças / pieces

10.19.107 **10.19.107** **10.19.105** **10.19.103** **10.19.101** **10.19.102** **10.19.104** **10.19.106** **10.19.108** **10.19.108**

Maxilar



15 14 13 12 11 21 22 23 24 25

Mandibular



45 44 43 42 41 31 32 33 34 35

Comprimento Length	
Torque Torque	
Ângulo Angle	

2,9 mm	2,9 mm	2,9 mm	2,3 mm	2,3 mm	2,3 mm	2,3 mm	2,9 mm	2,9 mm	2,9 mm
-22°	-17°	-11°	-1°	-1°	-1°	-1°	-11°	-17°	-22°
+2°	+2°	+5°	+2°	+2°	+2°	+2°	+5°	+2°	+2°

Reposições
Replacements **.022"**
10 peças / pieces

10.19.115 **10.19.113** **10.19.111** **10.19.109** **10.19.109** **10.19.110** **10.19.110** **10.19.112** **10.19.114** **10.19.116**

Morelli Max Prescrição Capelozza Padrão II com ganchos nos caninos e pré-molares

Kit 20 peças / pieces **10.19.905** Kit 200 peças / pieces **10.19.935** Slot **.022"**

Prescrição Capelozza *Max*

Comprimento Length	
Torque Torque	
Ângulo Angle	

2,9 mm	2,9 mm	2,9 mm	2,5 mm	3,2 mm	3,2 mm	2,5 mm	2,9 mm	2,9 mm	2,9 mm
-7°	-7°	-5°	+3°	+7°	+7°	+3°	-5°	-7°	-7°
0°	0°	+5°	+9°	+5°	+5°	+9°	+5°	0°	0°

Reposições
Replacements **.022"**
10 peças / pieces

10.19.107 **10.19.107** **10.19.117** **10.19.103** **10.19.101** **10.19.102** **10.19.104** **10.19.118** **10.19.108** **10.19.108**

Maxilar



15 14 13 12 11 21 22 23 24 25

Mandibular



45 44 43 42 41 31 32 33 34 35

Comprimento Length	
Torque Torque	
Ângulo Angle	

2,9 mm	2,9 mm	2,9 mm	2,3 mm	2,3 mm	2,3 mm	2,3 mm	2,9 mm	2,9 mm	2,9 mm
-22°	-17°	-11°	+4°	+4°	+4°	+4°	-11°	-17°	-22°
+2°	+2°	+5°	+2°	+2°	+2°	+2°	+5°	+2°	+2°

Reposições
Replacements **.022"**
10 peças / pieces

10.19.115 **10.19.113** **10.19.111** **10.19.119** **10.19.119** **10.19.120** **10.19.120** **10.19.112** **10.19.114** **10.19.116**

Morelli Max Prescrição Capelozza Padrão III com ganchos nos caninos e pré-molares

Prescrição Capelozza *Max*

Kit 20 peças / pieces Kit 200 peças / pieces Slot
10.19.906 **10.19.936** **.022"**

Comprimento Length
 Torque Torque
 Ângulo Angle

2,9 mm	2,9 mm	2,9 mm	2,5 mm	3,2 mm	3,2 mm	2,5 mm	2,9 mm	2,9 mm	2,9 mm
-7°	-7°	-2°	+10°	+14°	+14°	+10°	-2°	-7°	-7°
0°	0°	+11°	+9°	+5°	+5°	+9°	+11°	0°	0°

Reposições Replacements **.022"**

10.19.107	10.19.107	10.19.125	10.19.123	10.19.121	10.19.122	10.19.124	10.19.126	10.19.108	10.19.108
------------------	------------------	------------------	------------------	------------------	------------------	------------------	------------------	------------------	------------------

10 peças / pieces

Maxilar



Mandibular

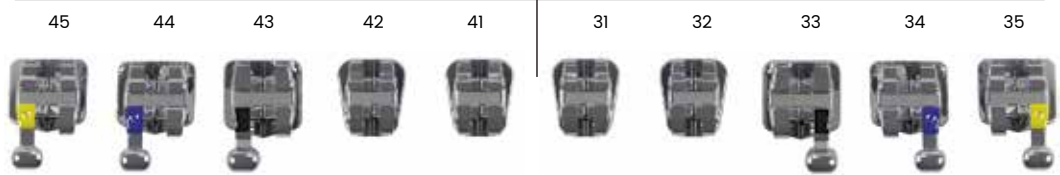

Comprimento Length
 Torque Torque
 Ângulo Angle

2,9 mm	2,9 mm	2,9 mm	2,3 mm	2,3 mm	2,3 mm	2,3 mm	2,9 mm	2,9 mm	2,9 mm
-22°	-17°	-11°	-6°	-6°	-6°	-6°	-11°	-17°	-22°
+2°	+2°	0°	0°	0°	0°	0°	0°	+2°	+2°

Reposições Replacements **.022"**

10.19.115	10.19.113	10.19.128	10.19.127	10.19.127	10.19.127	10.19.127	10.19.129	10.19.114	10.19.116
------------------	------------------	------------------	------------------	------------------	------------------	------------------	------------------	------------------	------------------

10 peças / pieces

Morelli Slim Max Prescrição Edgewise

Edgewise Slim *Max*

Kit 20 peças / pieces Kit 200 peças / pieces Slot
10.65.905 **10.65.935** **.022"**
10.65.904 **10.65.934** **.018"**

Comprimento Length
 Torque Torque
 Ângulo Angle

2,5 mm	2,5 mm	2,5 mm	2,2 mm	3,0 mm	3,0 mm	2,2 mm	2,5 mm	2,5 mm	2,5 mm
0°	0°	0°	0°	0°	0°	0°	0°	0°	0°
0°	0°	0°	0°	0°	0°	0°	0°	0°	0°

Reposições Replacements **.022"**

10.65.403	10.65.403	10.65.403	10.65.402	10.65.401	10.65.401	10.65.402	10.65.403	10.65.403	10.65.403
------------------	------------------	------------------	------------------	------------------	------------------	------------------	------------------	------------------	------------------

.018"

10.65.303	10.65.303	10.65.303	10.65.302	10.65.301	10.65.301	10.65.302	10.65.303	10.65.303	10.65.303
------------------	------------------	------------------	------------------	------------------	------------------	------------------	------------------	------------------	------------------

10 peças / pieces

Maxilar



Mandibular

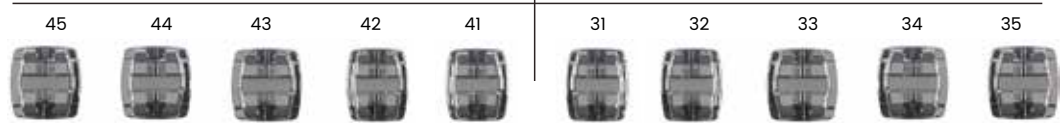

Comprimento Length
 Torque Torque
 Ângulo Angle

2,5 mm	2,5 mm	2,5 mm	2,2 mm	2,2 mm	2,2 mm	2,2 mm	2,5 mm	2,5 mm	2,5 mm
0°	0°	0°	0°	0°	0°	0°	0°	0°	0°
0°	0°	0°	0°	0°	0°	0°	0°	0°	0°

Reposições Replacements **.022"**

10.65.403	10.65.403	10.65.403	10.65.402	10.65.402	10.65.402	10.65.402	10.65.403	10.65.403	10.65.403
------------------	------------------	------------------	------------------	------------------	------------------	------------------	------------------	------------------	------------------

.018"

10.65.303	10.65.303	10.65.303	10.65.302	10.65.302	10.65.302	10.65.302	10.65.303	10.65.303	10.65.303
------------------	------------------	------------------	------------------	------------------	------------------	------------------	------------------	------------------	------------------

10 peças / pieces

Morelli Slim Max Prescrição Edgewise com gancho nos caninos

Kit 20 peças / pieces	Kit 200 peças / pieces	Slot
10.65.907	10.65.937	.022"
10.65.906	10.65.936	.018"

Edgewise Slim *Max*

Comprimento Length	2,5 mm	2,5 mm	2,5 mm	2,2 mm	3,0 mm	3,0 mm	2,2 mm	2,5 mm	2,5 mm	2,5 mm
Torque Torque	0°	0°	0°	0°	0°	0°	0°	0°	0°	0°
Ângulo Angle	0°	0°	0°	0°	0°	0°	0°	0°	0°	0°

Reposições Replacements	.022"	10.65.403	10.65.403	10.65.404	10.65.402	10.65.401	10.65.401	10.65.402	10.65.405	10.65.403	10.65.403
	.018"	10.65.303	10.65.303	10.65.304	10.65.302	10.65.301	10.65.301	10.65.302	10.65.305	10.65.303	10.65.303

10 peças / pieces

Maxilar

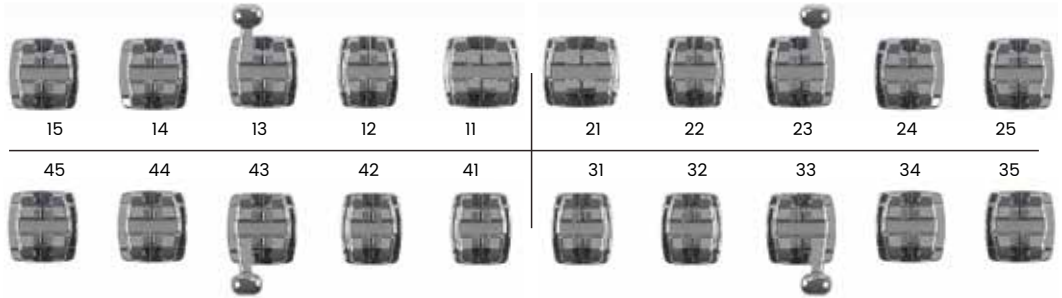

Mandibular

Comprimento Length	2,5 mm	2,5 mm	2,5 mm	2,2 mm	2,2 mm	2,2 mm	2,2 mm	2,5 mm	2,5 mm	2,5 mm
Torque Torque	0°	0°	0°	0°	0°	0°	0°	0°	0°	0°
Ângulo Angle	0°	0°	0°	0°	0°	0°	0°	0°	0°	0°

Reposições Replacements	.022"	10.65.403	10.65.403	10.65.405	10.65.402	10.65.402	10.65.402	10.65.404	10.65.403	10.65.403
	.018"	10.65.303	10.65.303	10.65.305	10.65.302	10.65.302	10.65.302	10.65.304	10.65.303	10.65.303

10 peças / pieces

Morelli Standard Prescrição Edgewise

Kit 20 peças / pieces	Slot
10.30.901	.022"
10.30.900	.018"

Edgewise Standard

Comprimento Length	3,0 mm	3,0 mm	3,0 mm	2,3 mm	3,4 mm	3,4 mm	2,3 mm	3,0 mm	3,0 mm	3,0 mm
Torque Torque	0°	0°	0°	0°	0°	0°	0°	0°	0°	0°
Ângulo Angle	0°	0°	0°	0°	0°	0°	0°	0°	0°	0°

Reposições Replacements	.022"	10.30.208	10.30.208	10.30.208	10.30.209	10.30.201	10.30.201	10.30.209	10.30.208	10.30.208	10.30.208
	.018"	10.30.106	10.30.106	10.30.106	10.30.107	10.30.101	10.30.101	10.30.107	10.30.106	10.30.106	10.30.106

10 peças / pieces

Maxilar

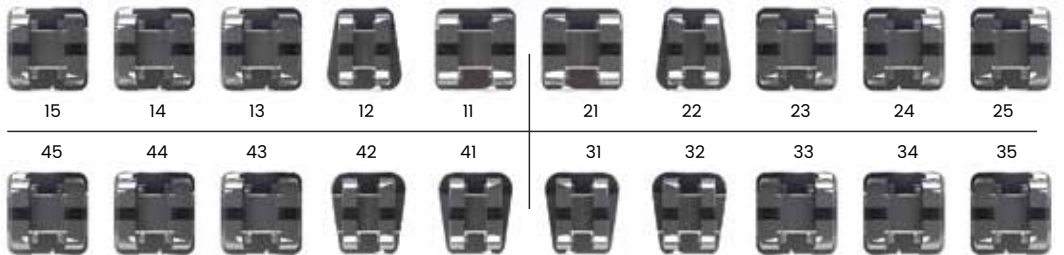

Mandibular

Comprimento Length	3,0 mm	3,0 mm	3,0 mm	2,3 mm	2,3 mm	2,3 mm	2,3 mm	3,0 mm	3,0 mm	3,0 mm
Torque Torque	0°	0°	0°	0°	0°	0°	0°	0°	0°	0°
Ângulo Angle	0°	0°	0°	0°	0°	0°	0°	0°	0°	0°

Reposições Replacements	.022"	10.30.208	10.30.208	10.30.208	10.30.209	10.30.209	10.30.209	10.30.209	10.30.208	10.30.208	10.30.208
	.018"	10.30.106	10.30.106	10.30.106	10.30.107	10.30.107	10.30.107	10.30.107	10.30.106	10.30.106	10.30.106

10 peças / pieces

Bráquetes Morelli Edgewise/Ricketts com ganchos nos caninos e pré-molares

Comprimento Length Torque Torque Ângulo Angle	3,0 mm	3,0 mm	3,0 mm						3,0 mm	3,0 mm	3,0 mm	
	0°	0°	0°						0°	0°	0°	
	0°	0°	0°						0°	0°	0°	
Reposições Replacements	.022"	10.30.211	10.30.211	10.30.211						10.30.212	10.30.212	10.30.212
	.018"	10.30.111	10.30.111	10.30.111						10.30.112	10.30.112	10.30.112
10 peças / pieces												
Maxilar												
	15	14	13	12	11	21	22	23	24	25		
Mandibular												
	45	44	43	42	41	31	32	33	34	35		
Comprimento Length Torque Torque Ângulo Angle	3,0 mm	3,0 mm	3,0 mm						3,0 mm	3,0 mm	3,0 mm	
	0°	0°	0°						0°	0°	0°	
	0°	0°	0°						0°	0°	0°	
Reposições Replacements	.022"	10.30.212	10.30.212	10.30.212						10.30.211	10.30.211	10.30.211
	.018"	10.30.112	10.30.112	10.30.112						10.30.111	10.30.111	10.30.111
10 peças / pieces												

Morelli Slim Prescrição Edgewise

Kit 20 peças / pieces

Slot

10.65.903

.022"

10.65.902

.018"

Edgewise Slim

Comprimento Length Torque Torque Ângulo Angle	2,5 mm	2,5 mm	2,5 mm	2,2 mm	3,0 mm	3,0 mm	2,2 mm	2,5 mm	2,5 mm	2,5 mm	
	0°	0°	0°	0°	0°	0°	0°	0°	0°	0°	
	0°	0°	0°	0°	0°	0°	0°	0°	0°	0°	
Reposições Replacements	.022"	10.65.206	10.65.206	10.65.206	10.65.203	10.65.201	10.65.201	10.65.203	10.65.206	10.65.206	10.65.206
	.018"	10.65.106	10.65.106	10.65.106	10.65.103	10.65.101	10.65.101	10.65.103	10.65.106	10.65.106	10.65.106
10 peças / pieces											
Maxilar											
	15	14	13	12	11	21	22	23	24	25	
Mandibular											
	45	44	43	42	41	31	32	33	34	35	
Comprimento Length Torque Torque Ângulo Angle	2,5 mm	2,5 mm	2,5 mm	2,2 mm	2,2 mm	2,2 mm	2,2 mm	2,5 mm	2,5 mm	2,5 mm	
	0°	0°	0°	0°	0°	0°	0°	0°	0°	0°	
	0°	0°	0°	0°	0°	0°	0°	0°	0°	0°	
Reposições Replacements	.022"	10.65.206	10.65.206	10.65.206	10.65.203	10.65.203	10.65.203	10.65.206	10.65.206	10.65.206	
	.018"	10.65.106	10.65.106	10.65.106	10.65.103	10.65.103	10.65.103	10.65.106	10.65.106	10.65.106	
10 peças / pieces											

Morelli Slim Prescrição Edgewise com gancho nos caninos

Edgewise Slim

Kit 20 peças / pieces

Slot

10.65.901

.022"

10.65.900

.018"

Comprimento Length	
Torque Torque	
Ângulo Angle	

2,5 mm	2,5 mm	2,5 mm	2,2 mm	3,0 mm	3,0 mm	2,2 mm	2,5 mm	2,5 mm	2,5 mm
0°	0°	0°	0°	0°	0°	0°	0°	0°	0°
0°	0°	0°	0°	0°	0°	0°	0°	0°	0°

Reposições Replacements	.022"
	.018"

10.65.206	10.65.206	10.65.204	10.65.203	10.65.201	10.65.201	10.65.203	10.65.205	10.65.206	10.65.206
------------------	------------------	------------------	------------------	------------------	------------------	------------------	------------------	------------------	------------------

10.65.106	10.65.106	10.65.104	10.65.103	10.65.101	10.65.101	10.65.103	10.65.105	10.65.106	10.65.106
------------------	------------------	------------------	------------------	------------------	------------------	------------------	------------------	------------------	------------------

10 peças / pieces

Maxilar



Mandibular

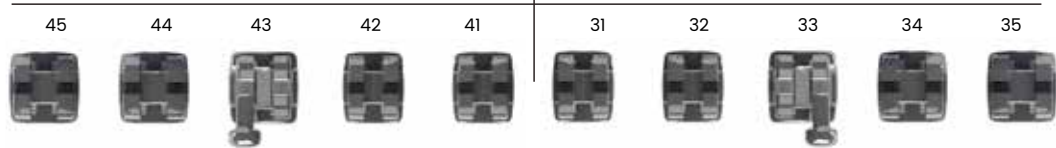

Comprimento Length	
Torque Torque	
Ângulo Angle	

2,5 mm	2,5 mm	2,5 mm	2,2 mm	2,2 mm	2,2 mm	2,2 mm	2,5 mm	2,5 mm	2,5 mm
0°	0°	0°	0°	0°	0°	0°	0°	0°	0°
0°	0°	0°	0°	0°	0°	0°	0°	0°	0°

Reposições Replacements	.022"
	.018"

10.65.206	10.65.206	10.65.205	10.65.203	10.65.203	10.65.203	10.65.203	10.65.204	10.65.206	10.65.206
------------------	------------------	------------------	------------------	------------------	------------------	------------------	------------------	------------------	------------------

10.65.106	10.65.106	10.65.105	10.65.103	10.65.103	10.65.103	10.65.103	10.65.104	10.65.106	10.65.106
------------------	------------------	------------------	------------------	------------------	------------------	------------------	------------------	------------------	------------------

10 peças / pieces

Bráquetes Morelli Edgewise/Ricketts com ganchos nos pré-molares

Comprimento Length	
Torque Torque	
Ângulo Angle	

3,0 mm	3,0 mm
0°	0°
0°	0°

3,0 mm	3,0 mm
0°	0°
0°	0°

Reposições Replacements	.022"
	.018"

10.30.211	10.30.211
10.30.111	10.30.111

10.30.212	10.30.212
10.30.112	10.30.112

10 peças / pieces

Maxilar



15	14	13	12	11	21	22	23	24	25
45	44	43	42	41	31	32	33	34	35

Mandibular



Comprimento Length	
Torque Torque	
Ângulo Angle	

3,0 mm	3,0 mm
0°	0°
0°	0°

3,0 mm	3,0 mm
0°	0°
0°	0°

Reposições Replacements	.022"
	.018"

10.30.212	10.30.212
10.30.112	10.30.112

10.30.211	10.30.211
10.30.111	10.30.111

10 peças / pieces

Morelli Actual Prescrição Ricketts com ganchos nos caninos e pré-molares

Ricketts Actual

Kit 20 peças / pieces

Slot

10.25.901

.018"

Comprimento Length	
Torque Torque	
Ângulo Angle	

2,5 mm	2,5 mm	2,7 mm	2,5 mm	3,2 mm	3,2 mm	2,5 mm	2,7 mm	2,5 mm	2,5 mm
0°	0°	+7°	+14°	+22°	+22°	+14°	+7°	0°	0°
0°	0°	+8°	+10°	+3°	+3°	+10°	+8°	0°	0°

Reposições
Replacements

.018"

10 peças / pieces

10.25.109 10.25.107 10.25.105 10.25.103 10.25.101 10.25.102 10.25.104 10.25.106 10.25.108 10.25.110

Maxilar



15 14 13 12 11 21 22 23 24 25
45 44 43 42 41 31 32 33 34 35

Mandibular



Comprimento Length	
Torque Torque	
Ângulo Angle	

2,5 mm	2,5 mm	2,7 mm	2,2 mm	2,2 mm	2,2 mm	2,2 mm	2,7 mm	2,5 mm	2,5 mm
0°	0°	+7°	0°	0°	0°	0°	+7°	0°	0°
0°	0°	+2°	0°	0°	0°	0°	+2°	0°	0°

Reposições
Replacements

.018"

10 peças / pieces

10.25.110 10.25.115 10.25.113 10.25.111 10.25.111 10.25.111 10.25.111 10.25.114 10.25.116 10.25.109

Morelli Actual Especial Prescrição Ricketts com gancho nos caninos e pré-molares

Ricketts Actual Especial

Kit 20 peças / pieces

Slot

10.25.900

.018"

Comprimento Length	
Torque Torque	
Ângulo Angle	

2,5 mm	2,5 mm	2,7 mm	2,5 mm	3,2 mm	3,2 mm	2,5 mm	2,7 mm	2,5 mm	2,5 mm
0°	0°	+7°	+10°	+22°	+22°	+10°	+7°	0°	0°
0°	0°	+8°	+10°	+3°	+3°	+10°	+8°	0°	0°

Reposições
Replacements

.018"

10 peças / pieces

10.25.125 10.25.107 10.25.119 10.25.123 10.25.101 10.25.102 10.25.124 10.25.120 10.25.108 10.25.126

Maxilar



15 14 13 12 11 21 22 23 24 25
45 44 43 42 41 31 32 33 34 35

Mandibular



Comprimento Length	
Torque Torque	
Ângulo Angle	

2,5 mm	2,5 mm	2,7 mm	2,2 mm	2,2 mm	2,2 mm	2,2 mm	2,7 mm	2,5 mm	2,5 mm
0°	0°	+7°	0°	0°	0°	0°	+7°	0°	0°
0°	0°	+2°	0°	0°	0°	0°	+2°	0°	0°

Reposições
Replacements

.018"

10 peças / pieces

10.25.115 10.25.115 10.25.121 10.25.111 10.25.111 10.25.111 10.25.111 10.25.122 10.25.116 10.25.116

Morelli Slim Prescrição Ricketts com ganchos nos caninos e pré-molares

Ricketts Slim

Kit 20 peças / pieces
10.25.905

Slot
.018"

Comprimento Length	
Torque Torque	
Ângulo Angle	

2,5 mm	2,5 mm	2,5 mm	2,2 mm	3,0 mm	3,0 mm	2,2 mm	2,5 mm	2,5 mm	2,5mm
0°	0°	+7°	+14°	+22°	+22°	+14°	+7°	0°	0°
0°	0°	+5°	+10°	+3°	+3°	+10°	+5°	0°	0°

Reposições
Replacements
10 peças / pieces

.018" **10.65.104** **10.65.104** **10.25.305** **10.25.303** **10.25.301** **10.25.302** **10.25.304** **10.25.306** **10.65.105** **10.65.105**

Maxilar

15	14	13	12	11	21	22	23	24	25

Mandibular







45	44	43	42	41	31	32	33	34	35





Comprimento Length	
Torque Torque	
Ângulo Angle	

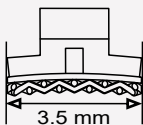

2,5 mm	2,5 mm	2,5 mm	2,2 mm	2,2 mm	2,2 mm	2,2 mm	2,5 mm	2,5 mm	2,5 mm
0°	0°	+7°	0°	0°	0°	0°	+7°	0°	0°
0°	0°	+5°	0°	0°	0°	0°	+5°	0°	0°

Reposições
Replacements
10 peças / pieces

.018" **10.65.105** **10.65.105** **10.25.307** **10.65.103** **10.65.103** **10.65.103** **10.65.103** **10.25.308** **10.65.104** **10.65.104**

Bráquete	Precrições Precription	Uso Use	Compr. Length	Torque Torque	Qty	Colagem / Bonding	
						Código / code	Código / code
						.018"	.022"
	Edgewise / Ricketts	$\frac{12 \ 11}{42 \ 41} \mid \frac{21 \ 22}{31 \ 32}$	3,0mm	0°	10	10.30.102	10.30.202
	Edgewise	$\frac{42 \ 41}{45 \ 44 \ 43} \mid \frac{31 \ 32}{33 \ 34 \ 35}$	1,8mm	0°	10	10.30.103	10.30.203
	Edgewise / Ricketts	$\frac{12 \ 22}{42 \ 41} \mid \frac{31 \ 32}{33 \ 34 \ 35}$	2,3mm	0°	10	10.30.104	10.30.205
	Edgewise	$\frac{15 \ 14 \ 13}{45 \ 44 \ 43} \mid \frac{23 \ 24 \ 25}{33 \ 34 \ 35}$	2,5mm	0°	10	-	10.30.206
	Edgewise / Ricketts	$\frac{15 \ 14 \ 13}{45 \ 44 \ 43} \mid \frac{23 \ 24 \ 25}{33 \ 34 \ 35}$	2,3mm	0°	10	10.30.105	10.30.207
	Edgewise / Ricketts	$\frac{12^* \ 22^*}{42 \ 41^{**} \ 31 \ 32^{**}}$ *Edgewise **Edgewise / Ricketts	2,3mm	0°	10	10.30.107	10.30.209
	Edgewise	$\frac{16 \ 26}{46 \ 36}$	3,4mm	0°	10	10.30.108	10.30.210

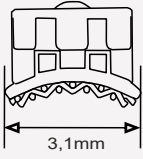
Prescrições Prescription	Uso Use	Compr. Length	Torque Torque	Qty	Colagem / Bonding		Soldagem / Welding		Bráquete Bracket
					Código / code		Código / code		
					.018"	.022"	.018"	.022"	
canal vertical na base	-	1,8mm	0°	10	-	10.40.201			
			+5°	10	-	10.40.202			
Edgewise	11 21	3,4mm	0°	10	-	-		10.31.201	
Edgewise	15 14 13 23 24 25 45 44 43 33 34 35	2,6mm	0°	10	-	-		10.31.206	
Edgewise	15 14 13 23 24 25 45 44 43 33 34 35	2,3mm	0°	10	-	-		10.31.207	

Aplicação Application	Uso Use	Compr. Length	Torque Torque	Qty	Colagem / Bonding	Medida dos fios recomendada nos canais verticais Recommended size of wires in the vertical slot Ø .016" (0,40mm)		
					Código / code			
Roth Canino Control	13 23	3,1mm	-2°	10	10.10.500			
Roth Canino Control	43 33	3,1mm	-11°	10	10.10.501			

Sugestão de aplicação



Classe III (*)



Rotação (*)



Side Winder (*)



Standard (*)



(*) Molas não fornecidas

TUBOS



Prescrições Prescription	Uso Use	Compr. Length	Tubo Tube Ø	Torque Torque	Distal Offset	Qtd Qty	Soldagem / Welding		Colagem / Bonding	
							Código e medidas		Código e medidas	
							.018"	.022"	.018"	.022"

Roth

Tubo simples com gancho / Simple tube with hook

Roth	17 16	3,5mm	-	-14°	14°	10	20.10.111	20.10.211	20.11.111	20.11.211
Roth	26 27	3,5mm	-	-14°	14°	10	20.10.112	20.10.212	20.11.112	20.11.212
Roth	47 46	3,5mm	-	-30°	4°	10	20.10.121	20.10.221	20.11.121	20.11.221
Roth	36 37	3,5mm	-	-30°	4°	10	20.10.122	20.10.222	20.11.122	20.11.222



Mini tubo simples com gancho / Simple mini tube with hook

Roth	17	2,5mm	-	-14°	0°	10	-	-	20.11.113	20.11.213
Roth	27	2,5mm	-	-14°	0°	10	-	-	20.11.114	20.11.214
Roth	47	2,5mm	-	-25°	0°	10	-	-	20.11.123	20.11.223
Roth	37	2,5mm	-	-25°	0°	10	-	-	20.11.124	20.11.224



Tubo bráquete simples conversível / Simple convertible bracket tube

Roth M.B.T. Capelozza	44 34	2,5mm	-	-17°	0°	10	-	-	-	20.11.225
-----------------------------	-------	-------	---	------	----	----	---	---	---	-----------



Tubo duplo conversível com gancho / Double convertible tube with hook

Roth	46	3,5mm	-	-30°	4°	10	20.10.311	20.10.411	20.11.311	20.11.411
Roth	36	3,5mm	-	-30°	4°	10	20.10.312	20.10.412	20.11.312	20.11.412



Tubo duplo conversível com gancho para placa lábio-ativa

Double convertible tube with hook for lip bumper

Roth	46	3,5mm	cervical 1,15mm .045"	-30°	4°	10	20.10.313	20.10.413	-	-
Roth	36	3,5mm	cervical 1,15mm .045"	-30°	4°	10	20.10.314	20.10.414	-	-



Tubo duplo conversível com gancho / Double convertible tube with hook

Roth	16	3,5mm	-	-14°	14°	10	-	20.10.417	-	20.11.417
Roth	26	3,5mm	-	-14°	14°	10	-	20.10.418	-	20.11.418



Prescrições Prescription	Uso Use	Compr. Length	Tubo Tube Ø	Torque Torque	Distal Offset	Qtd Qty	Soldagem / Welding		Colagem / Bonding	
							Código e medidas		Código e medidas	
							.018"	.022"	.018"	.022"

Tubo triplo conversível com gancho / Triple convertible tube with hook

Roth	16	3,5mm	oclusal 1,15mm .045"	-14°	14°	10	20.10.511	20.10.611	-	20.11.611
Roth	26	3,5mm	oclusal 1,15mm .045"	-14°	14°	10	20.10.512	20.10.612	-	20.11.612

Tubo duplo conversível com gancho / Double convertible tube with hook

Especial	17 16	3,5mm	-	0°	10°	10	-	-	-	20.11.419
Especial	26 27	3,5mm	-	0°	10°	10	-	-	-	20.11.420

compatível com a prescrição Roth / compatible to Roth prescription

Capelozza

Tubo simples conversível com gancho / Simple convertible tube with hook

Capelozza Roth	17 16	3,5mm	-	-10°	10°	10	-	20.19.100	-	20.19.200
Capelozza Roth	26 27	3,5mm	-	-10°	10°	10	-	20.19.101	-	20.19.201
Capelozza Roth	47 46	3,5mm	-	-25°	5°	10	-	20.19.102	-	20.19.202
Capelozza Roth	36 37	3,5mm	-	-25°	5°	10	-	20.19.103	-	20.19.203

Tubo Duplo conversível com gancho / Double convertible tube with hook

Capelozza (Padrãoil)	17 16 26 27	3,5mm	-	-10°	0°	10	-	20.19.300	-	20.19.301
-------------------------	---------------	-------	---	------	----	----	---	-----------	---	-----------

Tubo Triplo conversível com gancho / Triple convertible tube with hook

Capelozza (Padrãoil)	16 26	3,5mm	oclusal 1,15mm .045"	-10°	0°	10	-	20.19.500	-	-
-------------------------	---------	-------	----------------------------	------	----	----	---	-----------	---	---

Edgewise / Ricketts

Tubo simples / Simple Tube

Edgewise	17 16 26 27 47 46 36 37	5,2 mm	-	0°	0°	10	-	-	20.31.100	20.31.200
----------	--------------------------------	--------	---	----	----	----	---	---	-----------	-----------

Edgewise	17 16 26 27 47 46 36 37	5,2 mm	-	0°	0°	10	20.30.100	20.30.200	-	-
----------	--------------------------------	--------	---	----	----	----	-----------	-----------	---	---

Prescrições Prescription	Uso Use	Compr. Length	Tubo Tube Ø	Torque Torque	Distal Offset	Qtd Qty	Soldagem / Welding		Colagem / Bonding	
							Código e medidas		Código e medidas	
							.018"	.022"	.018"	.022"

Tubo simples especial sem gancho / Special simple tube with hook

Edgewise	$\frac{17\ 16}{47\ 46} \mid \frac{26\ 27}{36\ 37}$	3,3 mm	-	0°	0°	10	-	20.30.201	-	20.31.201
----------	--	--------	---	----	----	----	---	------------------	---	------------------



Tubo simples com gancho / Simple tube with hook

Edgewise	$\frac{17\ 16}{47\ 46} \mid \frac{26\ 27}{36\ 37}$	5,2 mm	-	0°	0°	10	-	20.30.230	-	20.31.230
Edgewise	$\frac{17\ 16}{47\ 46} \mid \frac{26\ 27}{36\ 37}$	5,2 mm	-	0°	0°	10	-	20.30.260	-	20.31.260



Tubo simples com gancho / Simple tube with hook

Edgewise	$\frac{17\ 16}{47\ 46} \mid \frac{26\ 27}{36\ 37}$	3,5 mm	-	0°	0°	10	20.30.141	20.30.241	20.31.141	20.31.241
----------	--	--------	---	----	----	----	------------------	------------------	------------------	------------------



Tubo simples conversível com gancho / Simple convertible tube with hook

Edgewise	$\frac{17\ 16}{47\ 46} \mid \frac{26\ 27}{36\ 37}$	3,5 mm	-	0°	0°	10	20.30.180	20.30.280	20.31.180	20.31.280
----------	--	--------	---	----	----	----	------------------	------------------	------------------	------------------



Tubo duplo com gancho / Double tube with hook

Ricketts	$\frac{17\ 16}{47\ 46} \mid \frac{26\ 27}{36\ 37}$	3,5 mm	-	0°	0°	10	20.40.163	-	20.41.163	-
Edgewise	$\frac{17\ 16}{47\ 46} \mid \frac{26\ 27}{36\ 37}$	3,5 mm	-	0°	0°	10	-	20.40.263	-	20.41.263
Edgewise	$\frac{17\ 16}{47\ 46} \mid \frac{26\ 27}{36\ 37}$	3,5 mm	-	0°	0°	10	*20.40.363		*20.41.363	



*Slot .018" para oclusal e .022" cervical

*Slot .018" for occlusal and .022" for cervical

Prescrições Prescription	Uso Use	Compr. Length	Tubo Tube Ø	Torque Torque	Distal Offset	Qtd Qty	Soldagem / Welding		Colagem / Bonding	
							Código e medidas		Código e medidas	
							.018"	.022"	.018"	.022"



Tubo duplo conversível com gancho / Double convertible tube with hook

Edgewise Ricketts	$\frac{16}{46} \frac{26}{36}$	3,5 mm	cervical 1,15 mm .045"	0°	0°	10	20.40.330	20.40.331	-	-
Edgewise Ricketts	$\frac{16}{46} \frac{26}{36}$	3,5 mm	cervical 1,30 mm .051"	0°	0°	10	20.40.430	20.40.431	-	-



Tubo duplo conversível / Double convertible tube

Edgewise Ricketts	$\frac{16}{46} \frac{26}{36}$	3,5 mm	-	0°	0°	10	20.40.500	20.40.501	20.41.500	20.41.501
----------------------	---------------------------------	--------	---	----	----	----	-----------	-----------	-----------	-----------



Tubo triplo com gancho / Triple tube with hook

Edgewise Ricketts	$\frac{16}{46} \frac{26}{36}$	3,5 mm	central 1,30 mm .051"	0°	0°	10	20.50.180	20.50.181	-	-
----------------------	---------------------------------	--------	-----------------------------	----	----	----	-----------	-----------	---	---

M.B.T



Tubo simples / Simple tube

M.B.T.	$\frac{37}{47}$	3,5 mm	-	-10°	0°	10	-	-	-	20.35.215
--------	-----------------	--------	---	------	----	----	---	---	---	-----------

Tubo simples conversível / Simple convertible tube



M.B.T.	$\frac{17}{26} \frac{16}{27}$	3,5 mm	-	-14°	10°	10	-	20.35.103	-	20.35.113
M.B.T.	$\frac{26}{46} \frac{27}{36}$	3,5 mm	-	-14°	10°	10	-	20.35.104	-	20.35.114
M.B.T.	$\frac{46}{46} \frac{36}{36}$	3,5 mm	-	-20°	0°	10	-	20.35.202	-	20.35.212



Tubo duplo conversível com gancho / Double convertible tube with hook

M.B.T.	$\frac{46}{46} \frac{36}{36}$	3,5 mm	-	-20°	0°	10	-	20.35.401	-	-
--------	---------------------------------	--------	---	------	----	----	---	-----------	---	---

Tubo duplo conversível com gancho / Double convertible tube with hook



M.B.T.	$\frac{16}{26}$	3,5 mm	cervical 1,15 mm .045"	-14°	10°	10	-	20.35.402	-	-
M.B.T.	$\frac{26}{46}$	3,5 mm	cervical 1,15 mm .045"	-14°	10°	10	-	20.35.403	-	-

Prescrições Prescription	Uso Use	Compr. Length.	Tubo Tube Ø	Torque Torque	Distal Offset	Qtd Qty	Soldagem / welding		Colagem / Bonding	
							Código e medidas		Código e medidas	
							.018"	.022"	.018"	.022"

Tubo duplo conversível com gancho para P.L.A. / Double convertible tube with hook for P.L.A

M.B.T.	$\frac{46}{36}$	3,5 mm	cervical 1,15mm .045"	-20°	0°	10	-	20.35.405	-	-
--------	-----------------	--------	-----------------------------	------	----	----	---	-----------	---	---



Tubo duplo conversível com gancho / Double convertible tube with hook

M.B.T.	$\frac{46}{36}$	3,5 mm	-	-20°	0°	10	-	-	-	20.35.416
--------	-----------------	--------	---	------	----	----	---	---	---	-----------



Tubo triplo conversível com gancho / Triple convertible tube with hook

M.B.T.	$\frac{16}{}$	3,5 mm	oclusal 1,15mm .045"	-14°	10°	10	-	20.35.501	-	-
M.B.T.	$\frac{26}{}$	3,5 mm	oclusal 1,15mm .045"	-14°	10°	10	-	20.35.502	-	-



Lingual

Aplicação Application	Uso Use	Compr. Length	Tubo Tube Ø	Torque Torque	Distal Offset	Qtd Qty	Soldagem / Welding	
							Código	
							2 x 0,90mm 2 x .036"	

Tubo lingual vertical com gancho / Vertical lingual tube with hook

Lingual	$\frac{26}{46}$	2,7 mm	-	0°	0°	10	20.61.202
Lingual	$\frac{16}{36}$	2,7 mm	-	0°	0°	10	20.61.203



Tubo lingual com gancho / Lingual tube with hook

Lingual	$\frac{16}{46}$ $\frac{26}{36}$	3,5 mm	-	0°	0°	10	20.61.206
---------	---------------------------------	--------	---	----	----	----	-----------



ACESSÓRIOS

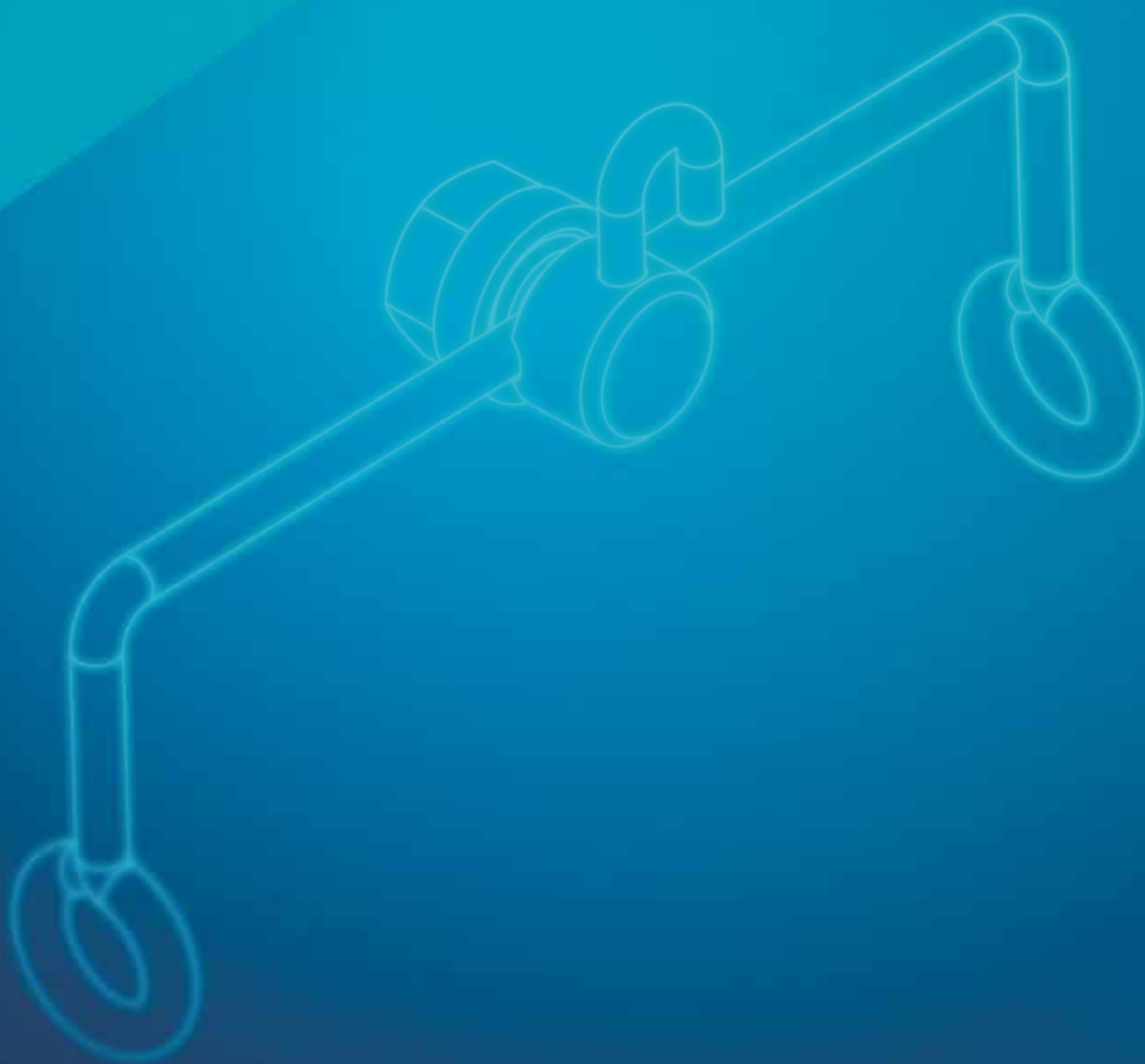

Tubo para ativadores com barra / Tube for activators with bar



Medidas Size	Qty Qty	Código Code
Ø1,15mm Ø.045"	10	30.05.145
Ø1,30mm Ø.051"	10	30.05.151



Botões linguais / Lingual button

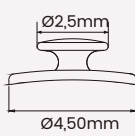

Tipo Type	Medidas Size	Qty Qty	Código Code
Para Soldagem For Welding		10	30.10.105

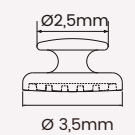

Convexo para colagem Convex for bonding		10	30.10.202
--	---	----	------------------

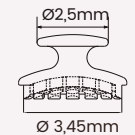
Côncavo para colagem Concave for Bonding		10	30.10.203
---	---	----	------------------

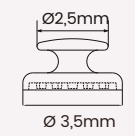
Lingual para colagem Lingual for bonding		10	30.10.205
---	---	----	------------------

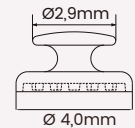
Composite para colagem Composite for bonding		10	30.10.206
---	---	----	------------------



Gancho para soldagem / Hook for welding

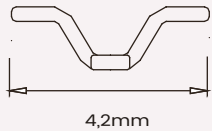

Medidas Size	Qtd Qty	Código Code
	100	30.20.101



Gancho para tração de dentes inclusos Hook for traction of non erupted teeth

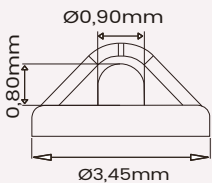

	10	30.21.104
---	-----------	------------------



Gancho para tração de dentes inclusos com corrente Hook for traction of non erupted teeth with chain

O gancho é colado ao dente impactado cuja corrente permanece ancorada no arco intraoral. A extrusão do dente se verifica à medida que aparecem os elos que uma vez contados, identificam a movimentação e o posicionamento do dente.

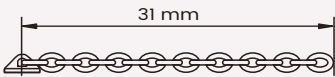

	10	30.21.107
---	-----------	------------------



Barra palatina loop mesial e distal

Palatal bar with mesial and distal loop

A barra palatina é um dispositivo que se conecta aos tubos linguais. Utilizada com diversas finalidades, pode gerar forças para giroversão, intrusão ou torque, bem como **funcionar como reforço de ancoragem.**

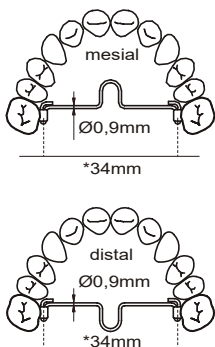

Medidas Size	Qtd Qty	Código Mesial Mesia code	Código Distal Distal Code
*34 x Ø0,9mm	10	30.30.034	30.30.134
37 x Ø0,9mm	10	30.30.037	30.30.137
39 x Ø0,9mm	10	30.30.039	30.30.139
41 x Ø0,9mm	10	30.30.041	30.30.141
43 x Ø0,9mm	10	30.30.043	30.30.143
45 x Ø0,9mm	10	30.30.045	30.30.145
47 x Ø0,9mm	10	30.30.047	30.30.147
49 x Ø0,9mm	10	30.30.049	30.30.149
52 x Ø0,9mm	10	30.30.052	30.30.152
55 x Ø0,9mm	10	30.30.055	30.30.155



Tipo Type	Medidas Size	Qtd Qty	Código Code
--------------	-----------------	------------	----------------

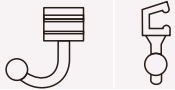
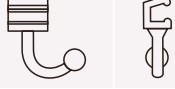

Gancho ponta bola curvo para arco
Ball curved tip hook for arch

Direito Right slot .022"		10	30.40.003
Esquerdo Left slot .022"		10	30.40.004

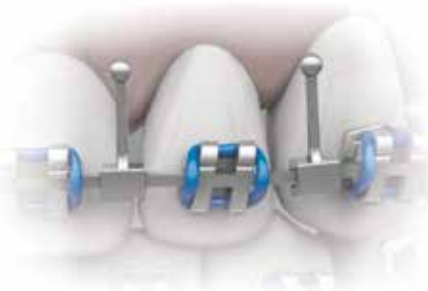

Gancho ponta bola reto para arco
Ball straight tip hook for arch

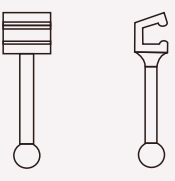
slot .022"		10	30.40.005
------------	---	-----------	------------------

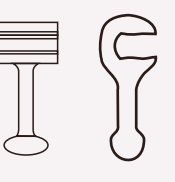

Gancho ponta bola universal para arco
Ball universal tip hook for arch

slot .022"		10	30.40.009
------------	---	-----------	------------------



Tubo cruzado / Cross tube

-	.022"	10	30.40.006
---	-------	-----------	------------------



Tubo cruzado com recuo cervical
Cervical offset cross tube

-	.022"	10	30.40.016
---	-------	-----------	------------------



Stop para arcos retangulares / Stop for rectangular arches

Eficiente para conter ou limitar movimentação de arcos e acessórios ortc além de evitar o incomodo causado pelo deslocamento do arco na distc



Medidas Size	Qtd Qty	Código Code
 .022"	10	30.40.008



Stop para arcos redondos / Stop for round arches

Projetados para demarcação de linha média ou travamento dos arcos ortodônticos redondos, principalmente evitando o desconforto por deslocamento do arco na distal do tubo. Limita o movimento lateral sem causar deformações. É empregado em todas as técnicas ortodônticas incluindo bráquetes autoligados.



 .021" Ø 0,54mm	25	30.40.020
---	----	-----------



Tubos telescópicos / Telescopic tube

Construídos em aço inoxidável, são utilizados na composição de alguns aparelhos ortopédicos e ortodônticos que apresentam movimentações deslizante sobre um fio ou haste. Como por exemplo os Aparelhos Protatores Mandibulares (APM), utilizados para correções de maloclusões de classe II.



Indicado para fios até Indicated for wires up to	Qtd Qty	Comprimento Length	Código Code
0,80mm	05	330mm	30.40.030
0,90mm	05	330mm	30.40.031
1,40mm	05	330mm	30.40.032



Grampo ponta bola / Headed ball clasp

O Grampo Ponta Bola é utilizado na confecção de aparelhos removíveis, para criar pontos de "retenção" por meio de sua esfera que se prende por pressão aos dentes.

Dimensões Dimensions	Qtd Qty	Comprimento Length	Código Code
Haste: Ø 0,8mm; Bola: Ø 1,5mm	50	38mm	30.40.041



Distalizador de molares tipo Jones universal Molar Distalizer Type Jones Universal

Este dispositivo é utilizado para distalizar molares superiores e oferece forças constantes. A ativação da mola de níquel titânio libera forças de 70 a 75gf, quando submetido à compressões médias de 5 mm.

Tamanho (L) Size (L)	Compressão* Compression*	Força* Force*	Qtd Qty	Código Code
15mm	3mm	60gf	02	30.45.003
	4mm	65gf		
	5mm	70gf		
	6mm	75gf		
	7mm	80gf		

Mola NiTi

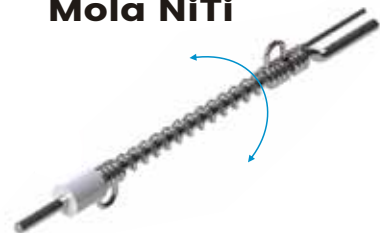

Olhal móvel cervical/occlusal para ancoragem

Movable cervical / occlusal eyelet for anchorage

*Valores médios
*Medium values

L = 15mm

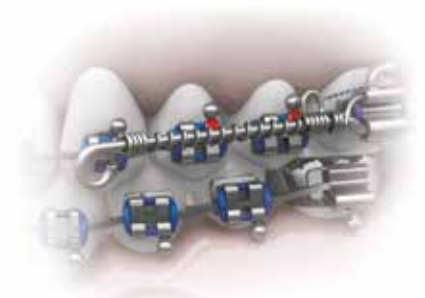
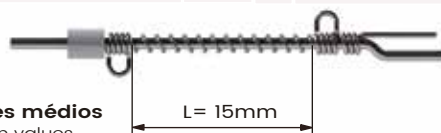

Stop e guia de mordida / Stop and Bite Guide

A principal função do Stop e Guia é diminuir o impacto dos dentes superiores com os bráquetes inferiores, pois ele trabalha abrindo a mordida, e ao mesmo tempo proporciona a reeducação e o descanso muscular.



Medidas Size	Qtd Qty	Código Code
3.6mm x 4.05mm	10	30.60.001

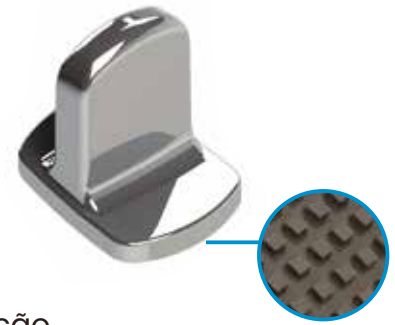

Cursor para Mesialização e Distalização

Sliding Jig for Mesialization and Distalization

O Cursor Morelli é um dispositivo intrabucal, instalado no arco intraoral, que permite a ancoragem de molas ou elásticos em um gancho de posição ajustável. A regulagem da força clínica é feita através do posicionamento do gancho ao longo do cursor, com uso da chave do Gurin. Fio Ø 0,7mm

Medidas Type	Tipo Type	Qtd Qty	Código Code
12mm	Curto – Sup. Esquerdo / Inf. Direito Short - UL/LR	10	30.45.011
12mm	Curto – Sup. Direito / Inf. Esquerdo Short - UR/LL	10	30.45.012
18mm	Médio – Sup. Esquerdo / Inf. Direito Medium - UL/LR	10	30.45.013
18mm	Médio – Sup. Direito / Inf. Esquerdo Medium - UR/LL	10	30.45.014
32mm	Longo – Sup. Esquerdo / Inf. Direito Long - UL/LR	10	30.45.015
32mm	Longo – Sup. Direito / Inf. Esquerdo Long - UR/LL	10	30.45.016

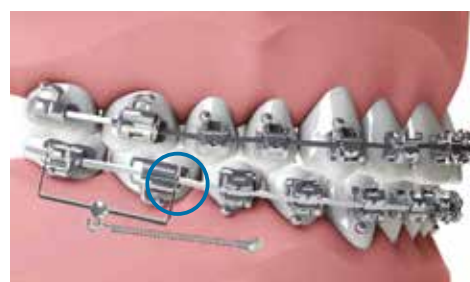

Mini esporão educador lingual

Mini Spur Tongue Educator

O Mini Esporão induz a língua a diminuir a pressão sobre os dentes anteriores, superiores e/ou inferiores, ao auxiliar nos tratamentos de secção digital (chupar o dedo), correção de mordidas abertas em redução de recidivas.

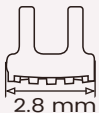

Medidas Size	Qtd Qty	Código Code
	10	30.60.002

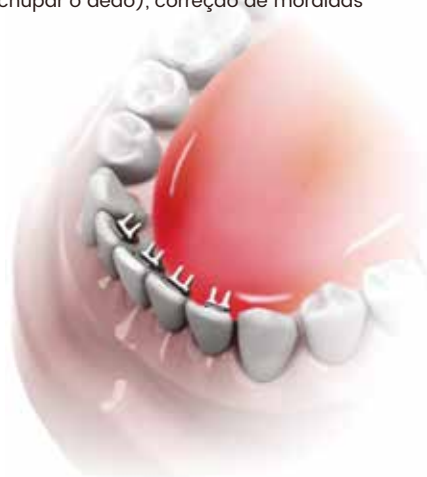

Gurin

São dispositivos que aplicados aos arcos ortodônticos, com auxílio da chave sextavada*, permitem a ancoragem de dispositivos diretamente no arco.

Gurin com slot redondo fechado

Gurin with closed round slot



Tipo Type	Medidas Size	Qtd Qty	Código Code
-	.022" ajustável	10	35.05.001



Gurin com slot redondo fechado e gancho

Gurin with closed round slot and hook



Tipo Type	Medidas Size	Qtd Qty	Código Code
direito / right	.022" ajustável adjustable	10	35.05.002
esquerdo / left		10	35.05.003



75.02.011

*A chave para o Gurin se encontra na página 99

*Gurin key in page 99

Gurin com slot redondo fechado e gancho haste longa

Gurin with closed round slot and right hook



Tipo Type	Medidas Size	Qtd Qty	Código Code
direito right	.022" ajustável adjustable	05	35.05.004
esquerdo left		05	35.05.005



Gurin com slot retangular aberto

Gurin with open rectangular round slot



Tipo Type	Medidas Size	Qtd Qty	Código Code
universal	.022" ajustável adjustable	10	35.05.011



Gurin com slot retangular aberto e gancho

Gurin with open rectangular slot and hook





Tipo Type	Medidas Size	Qtd Qty	Código Code
direito right	.022" ajustável adjustable	10	35.05.012
esquerdo left		10	35.05.013



Molas de tração e compressão / Traction and compression springs

As molas Morelli oferecem forças leves e contínuas, permitindo aumentar os intervalos das ativações. São excelentes dispositivos para obtenção de forças de tração ou compressão. As molas fechadas para tração apresentam extremidades preparadas para adaptação aos acessórios e estão disponíveis nos tamanhos 7, 9, 12 e 15mm.

Molas de CrNi / Spring CrNi

Tipo Type	Tamanho Size	Medidas Size	Qtd Qty	Código Code
aberta (compressão) open (compression)	1 metro	 Ø interno / internal 0,80mm (.032")	1	35.20.060
fechada (tração) closed (traction)	1 metro	 Ø interno / internal 0,80mm (.032")	1	35.20.061



Molas de NiTi / Spring NiTi

aberta (compressão) open (compression)	178mm	 Ø interno / internal 0,76mm (.030")	03	35.20.062
--	-------	---	----	-----------



Molas de NiTi aberta e fechada

Spring NiTi open and closed

aberta e fechada (compressão) open and closed (compression)	178mm	 Ø interno / internal 1,00mm (.040")	03	35.20.072
---	-------	--	----	-----------

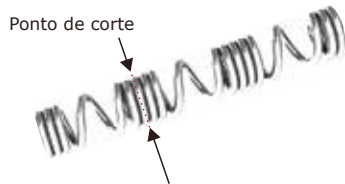

Dica

Para evitar a ponta da espiral aberta, recomenda-se cortar a mola na espiral fechada.

Molas de NiTi fechada / Spring NiTi closed

Tipo Type	Tamanho Size	Amplitude de aplicação Application Amplitude	Força Force	Qtd Qty	Código Code
fechada (tração) closed (traction)	7mm	10 a 15 mm	200g	04	35.20.064
	9mm	15 a 25 mm			35.20.065
	12mm	25 a 35 mm			35.20.066
	15mm	35 a 45 mm			35.20.067



Ø 1.6 mm

Molas de NiTi fechada para miniparafuso

Spring NiTi closed for miniscrew

fechada (tração) closed (traction)	7mm	10 a 15 mm	200g	04	37.30.001
	9mm	15 a 25 mm			37.30.002
	12mm	25 a 35 mm			37.30.003
	15mm	35 a 45 mm			37.30.004



Ø 2.3 mm



Tela malha 80 / Orthodontic Wire Mesh

Utilizada para confecção de base para colagem em tubos e demais peças. Utiliza fios trançados de aço inoxidável com 80 pontos/pol.

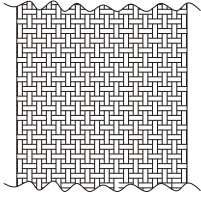

Tipo Type	Medidas Size	Qtd Qty	Código Code
CrNi	fio = Ø0,12 100 x 100mm	1	35.11.001



Solda de prata / Silver solder

Fio de solda prata de fácil aplicação isento de material tóxico.



em rolo / roll 56% (Ag) Fusão / Fusion = 650°C Ø0,5mm 5,0m	1	35.30.010
--	---	-----------



em vareta / Stick 56% (Ag) Fusão / Fusion = 650°C Ø0,8mm 300mm	04	35.30.011
--	----	-----------



em vareta / Stick 56% (Ag) Fusão / Fusion = 650°C Ø0,8mm 300mm	10	35.30.013
--	----	-----------



Pasta para solda prata / Solder flux

Material utilizado como fluxo indispensável para unir metais através de brasagem, permitindo soldas uniformes e sem bolhas.

Medidas Size	Qtd Qty	Código Code
20 ml	1	35.30.020



Cera ortodôntica de proteção / Orthodontic wax protection

A Cera de Proteção desenvolvida pela Morelli oferece conforto durante a adaptação ao aparelho ortodôntico, além de evitar as **consultas de urgência** e aumentar a colaboração dos pacientes em início do tratamento. Aromatizado com sabor menta.

Qtd Qty	Código Code
10 cartelas / cards	35.33.001

Qtd Qty	Código Code
1 cartela / card	35.33.002



ANCORAGEM ABSOLUTA

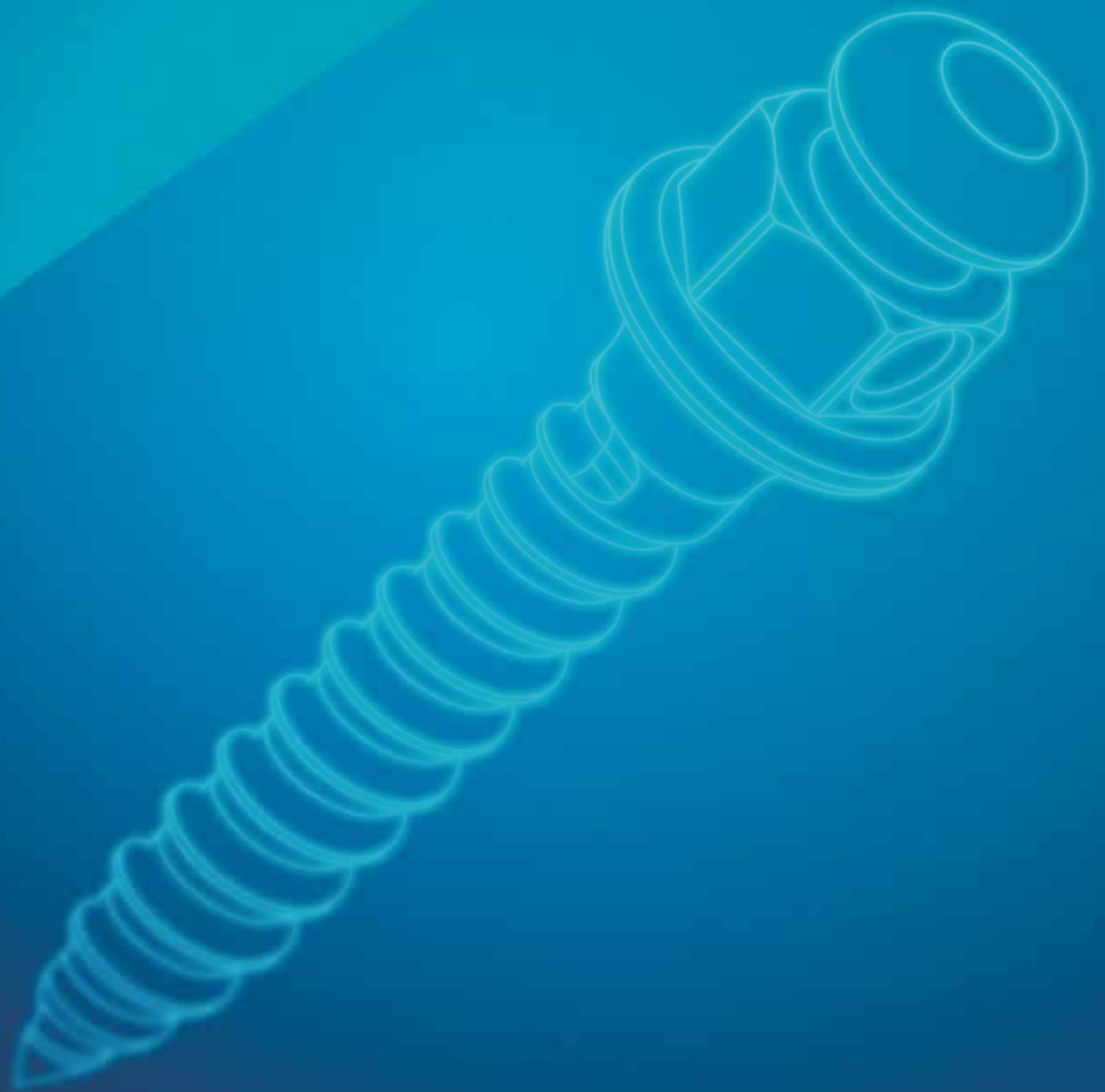

Este sistema revoluciona a ancoragem com fios e acessórios ortodônticos por oferecer liberdade ao Ortodontista para executar as movimentações dentárias, sem a dependência da colaboração do paciente.



Comprimento Length	Transmucosa Transmucosal	Diametro Diameter	Qtd Qty	Código Code
6mm	1mm	Ø1.5mm	2	37.10.101
8mm	1mm	Ø1.5mm	2	37.10.102
6mm	2mm	Ø1.5mm	2	37.10.201
8mm	2mm	Ø1.5mm	2	37.10.202
10mm	2mm	Ø1.5mm	2	37.10.203

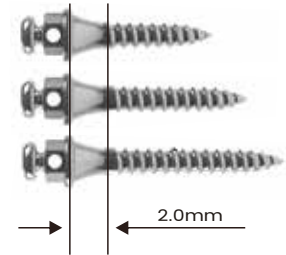
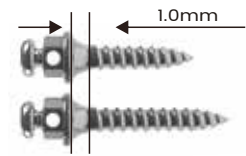

Produto esterilizado por radiação gama
Product sterilized by gamma radiation

Kit de ferramentas / Tool kit

Conjunto completo de ferramentas cujo estojo organizador é fabricado em polímero de engenharia, resistente às deformações causadas por altas temperaturas de autoclave. As ferramentas, exceto o estojo organizador, podem ser adquiridas separadamente.



Medidas Size	Qtd Qty	Código Code
60mm  100mm	1	37.20.001



Ponta-lança / Spear Tip

Utilizada para facilitar a entrada na gengiva e marcação do osso a ser perfurado pelo Miniparafuso.



Medidas Size	Qtd Qty	Código Code
	1	



Chave hexagonal - longa e cur

Para encaixar o Miniparafuso. Estão equipadas com anel de retenção em Nitinol, durável e seguro.



	1	
--	---	--



	1	37.20.012
--	---	-----------



Veja mola de Niti fechada para Miniparafuso na página 49

NiTi spring for miniscrew page 49

Chave hexagonal - digital / Hexagonal Digital Key

Esta chave poderá ser utilizada em espaços reduzidos, destinada a instalação e remoção dos Miniparafusos ortodônticos.



Medidas Size	Qtd Qty	Código Code
<p>25mm</p>	1	37.20.013



Chave de mão / Hand Key

Construção sólida, se acomoda confortavelmente na palma da mão e libera os dedos para girar o Miniparafuso com segurança e firmeza.



<p>93mm</p>	1	37.20.014
-------------	---	-----------

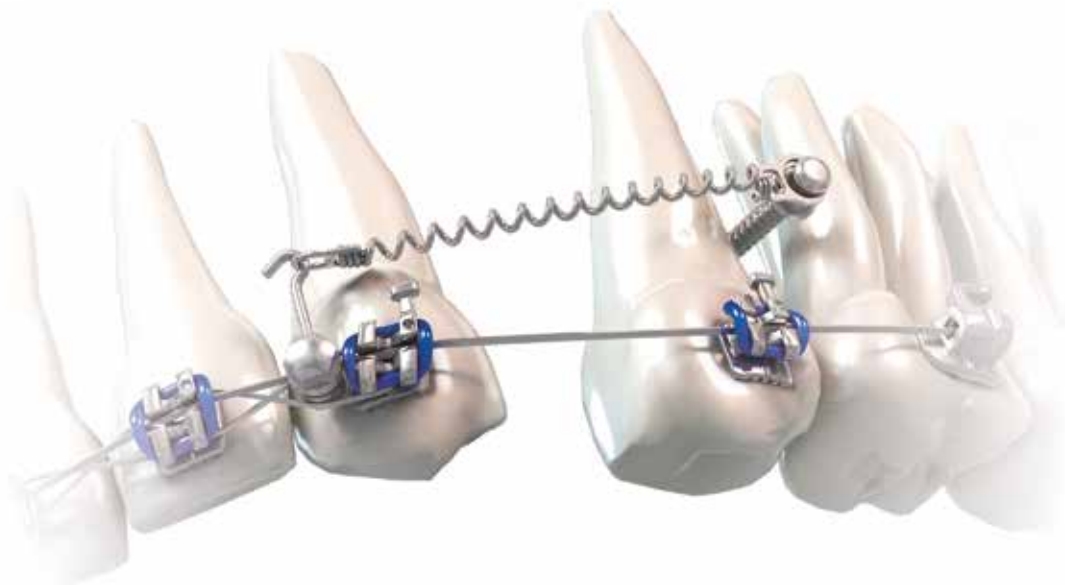

Veja mola de Niti fechada para Miniparafuso na página 49
Niti spring for miniscrew page 49

BANDAS



Bandas universais para molares / Universal bands for molars

As bandas universais têm perímetros internos que variam de 28 a 42mm, correspondendo aos perímetros dos dentes.



L	U
Banda para 1º e 2º molar inferior direito/esquerdo Band for 1º and 2º molar lower right / left	Banda para 1º e 2º molar superior direito/esquerdo Band for 1º and 2º molar upper right / left



Medidas Size	Qtd Qty	Código / Code	
		47 46 36 37	17 16 26 27
28	10	40.01.280	40.02.280
28,5	10	40.01.285	40.02.285
29	10	40.01.290	40.02.290
29,5	10	40.01.295	40.02.295
30	10	40.01.300	40.02.300
30,5	10	40.01.305	40.02.305
31	10	40.01.310	40.02.310
31,5	10	40.01.315	40.02.315
32	10	40.01.320	40.02.320
32,5	10	40.01.325	40.02.325
33	10	40.01.330	40.02.330
33,5	10	40.01.335	40.02.335
34	10	40.01.340	40.02.340
34,5	10	40.01.345	40.02.345
35	10	40.01.350	40.02.350
35,5	10	40.01.355	40.02.355
36	10	40.01.360	40.02.360
36,5	10	40.01.365	40.02.365
37	10	40.01.370	40.02.370
37,5	10	40.01.375	40.02.375
38	10	40.01.380	40.02.380
38,5	10	40.01.385	40.02.385
39	10	40.01.390	40.02.390
39,5	10	40.01.395	40.02.395
40	10	40.01.400	40.02.400
40,5	10	40.01.405	40.02.405
41	10	40.01.410	40.02.410
41,5	10	40.01.415	40.02.415
42	10	40.01.420	40.02.420

Dica

Para uma solda a ponto eficiente, recomenda-se não utilizar lixas e sim uma lima para a manutenção dos eletrodos.

Veja Alcadores de bandas na página 93
See bands seater on page 93



Bandas anatômicas para molares / Anatomical bands for molars

Confeccionadas em aço inoxidável, as bandas anatômicas Morelli reproduzem a morfologia dos molares, permitindo ótima adaptação. Disponíveis para molares superiores e inferiores, lado direito e esquerdo.



Medidas Size	Qtd Qty	Código / Code		Código / Code	
		47 46	36 37	17 16	26 27
29	10	40.12.290		40.22.290	
29,5	10	40.12.295		40.22.295	
30	10	40.12.300		40.22.300	
30,5	10	40.12.305		40.22.305	
31	10	40.12.310		40.22.310	
31,5	10	40.12.315		40.22.315	
32	10	40.12.320		40.22.320	
32,5	10	40.12.325		40.22.325	
33	10	40.12.330		40.22.330	
33,5	10	40.12.335		40.22.335	
34	10	40.12.340		40.22.340	
34,5	10	40.12.345		40.22.345	
35	10	40.12.350		40.22.350	
35,5	10	40.12.355		40.22.355	
36	10	40.12.360		40.22.360	
36,5	10	40.12.365		40.22.365	
37	10	40.12.370		40.22.370	
37,5	10	40.12.375		40.22.375	
38	10	40.12.380		40.22.380	
38,5	10	40.12.385		40.22.385	
39	10	40.12.390		40.22.390	
39,5	10	40.12.395		40.22.395	
40	10	40.12.400		40.22.400	
40,5	10	40.12.405		40.22.405	
41	10	40.12.410		40.22.410	
41,5	10	40.12.415		40.22.415	
42	10	40.12.420		40.22.420	



10 peças
10 pieces



Banda para pré-molar superior / Band for upper premolar

As bandas de pré-molares são dispositivos de ancoragem utilizados em tratamentos de expansão da maxila associada à aparelhos disjuntores e distalizadores tipo Haas e Hyrax, Jones Jig e botões de Nance. Também pode ser usado em casos de quedas recorrentes de bráquetes, onde o mesmo é soldado na banda.

BU

Superior
Upper

Tamanho Size	Qtd Qty	Código / Code	
		15 14	25 24
12	10		40.50.012
13	10		40.50.013
14	10		40.50.014
15	10		40.50.015
16	10		40.50.016
17	10		40.50.017
18	10		40.50.018
19	10		40.50.019
20	10		40.50.020
21	10		40.50.021
22	10		40.50.022
23	10		40.50.023
24	10		40.50.024
25	10		40.50.025
26	10		40.50.026
27	10		40.50.027
28	10		40.50.028
29	10		40.50.029
30	10		40.50.030
31	10		40.50.031
32	10		40.50.032



Bandas com Tubo e Acessório a pronta entrega.

Para pedir sua Banda Anatômica com Tubo Soldado siga os seguintes passos:

1 - Escolha a Banda "Inferior ou Superior".

2 - Escolha a medida da Banda.

3 - Escolha o Tubo e/ou Acessório.

4 - Identifique o código do cruzamento para efetuar o seu pedido.

CE 0434

Banda Anatômica Superior com Tubo e Acessório

Medida	Quantidade	L	R	Código
29	40.22.290	R	L	20.10.211
29,5	40.22.295	R	L	20.10.212
30	40.22.300	R	L	30.20.101
30,5	40.22.305	R	L	
31	40.22.310	R	L	
31,5	40.22.315	R	L	
32	40.22.320	R	L	
32,5	40.22.325	R	L	
33	40.22.330	R	L	48.11.009
34	40.22.340	R	L	48.11.010
34,5	40.22.345	R	L	48.11.011

Você receberá 1 Par (Direito/Esquerdo do conjunto escolhido).

Bandas com Tubo e Acessório a pronta entrega.









Exemplos:











Família 47
Banda com Tubo





Direita (R)	Esquerda (L)
+	+
=	
<p>Código 47.10.006 2 un</p>	

Família 48
Banda com Tubo e Acessório

Direita (R)	Esquerda (L)
+	+
+	+
=	
<p>Código 48.11.009 2 un</p>	

Banda Anatómica Inferior com tubo Anatomical Band Lower with Tube Prescrição / Prescription				Tubo Simples / Single Tube			Tubo Duplo / Double Tube				
				Roth	Edgewise Ricketts	Edgewise Ricketts	Roth	Roth	M.B.T.	Edgewise Ricketts	Edgewise Ricketts
Torque / Torque				-30°	0°	0°	-30°	-30°	-20°	0°	0°
Distal - Offset				4°	0°	0°	4°	4°	0°	0°	0°
Tubo / Tube Ø				-	-	-	-	.045"	-	.051"	-
Slot				.022"	.022"	.022"	.022"	.022"	.022"	.022"	.018"
											
Medidas Size	Bandas Bands	R L	Qty	20.10.221	20.30.200	20.30.241	20.10.411	20.10.413	20.35.401	20.40.431	20.40.163
				20.10.222			20.10.412	20.10.414			
29	40.12.290	R L	2	47.10.001	-	-	47.20.001	-	-	-	-
29,5	40.12.295	R L	2	47.10.002	-	-	47.20.002	-	-	-	-
30	40.12.300	R L	2	47.10.003	-	-	47.20.003	-	-	-	-
30,5	40.12.305	R L	2	47.10.004	-	-	47.20.004	-	-	-	-
31	40.12.310	R L	2	47.10.005	-	-	47.20.005	47.20.105	-	-	47.20.605
31,5	40.12.315	R L	2	47.10.006	-	-	47.20.006	47.20.106	-	-	47.20.606
32	40.12.320	R L	2	47.10.007	47.10.107	-	47.20.007	47.20.107	47.20.307	-	47.20.607
32,5	40.12.325	R L	2	47.10.008	47.10.108	-	47.20.008	47.20.108	47.20.308	-	47.20.608
33	40.12.330	R L	2	47.10.009	47.10.109	-	47.20.009	47.20.109	47.20.309	47.20.209	47.20.609
33,5	40.12.335	R L	2	47.10.010	47.10.110	-	47.20.010	47.20.110	47.20.310	47.20.210	47.20.610
34	40.12.340	R L	2	47.10.011	47.10.111	47.10.211	47.20.011	47.20.111	47.20.311	47.20.211	47.20.611
34,5	40.12.345	R L	2	47.10.012	47.10.112	47.10.212	47.20.012	47.20.112	47.20.312	47.20.212	47.20.612
35	40.12.350	R L	2	47.10.013	47.10.113	47.10.213	47.20.013	47.20.113	47.20.313	47.20.213	47.20.613
35,5	40.12.355	R L	2	47.10.014	47.10.114	47.10.214	47.20.014	47.20.114	47.20.314	47.20.214	47.20.614
36	40.12.360	R L	2	47.10.015	47.10.115	47.10.215	47.20.015	47.20.115	47.20.315	47.20.215	47.20.615
36,5	40.12.365	R L	2	47.10.016	47.10.116	47.10.216	47.20.016	47.20.116	47.20.316	47.20.216	47.20.616
37	40.12.370	R L	2	47.10.017	47.10.117	47.10.217	47.20.017	47.20.117	47.20.317	47.20.217	47.20.617
37,5	40.12.375	R L	2	47.10.018	47.10.118	47.10.218	47.20.018	47.20.118	47.20.318	47.20.218	47.20.618
38	40.12.380	R L	2	47.10.019	47.10.119	47.10.219	47.20.019	47.20.119	47.20.319	47.20.219	47.20.619
38,5	40.12.385	R L	2	47.10.020	47.10.120	47.10.220	47.20.020	47.20.120	47.20.320	47.20.220	47.20.620
39	40.12.390	R L	2	47.10.021	47.10.121	47.10.221	47.20.021	47.20.121	47.20.321	47.20.221	-
39,5	40.12.395	R L	2	47.10.022	47.10.122	47.10.222	47.20.022	47.20.122	47.20.322	-	-
40	40.12.400	R L	2	47.10.023	47.10.123	47.10.223	47.20.023	47.20.123	47.20.323	-	-
40,5	40.12.405	R L	2	47.10.024	47.10.124	-	47.20.024	47.20.124	47.20.324	-	-
41	40.12.410	R L	2	47.10.025	47.10.125	-	47.20.025	47.20.125	47.20.325	-	-
41,5	40.12.415	R L	2	47.10.026	47.10.126	-	47.20.026	47.20.126	47.20.326	-	-
42	40.12.420	R L	2	47.10.027	47.10.127	-	47.20.027	47.20.127	47.20.327	-	-

Banda Anatómica Superior com tubo Anatomical Band Upper with Tube Prescrição / Prescription Torque / Torque Distal - Offset Tubo / Tube Ø Slot 				Tubo Simples / Single Tube			Tubo Duplo / Double Tube				Tubo Triplo / Triple Tube	
				Roth	Edgewise Ricketts	Edgewise Ricketts	Roth	M.B.T.	Edgewise Ricketts	Edgewise Ricketts	Roth	M.B.T.
				-14°	0°	0°	-14°	-14°	0°	0°	-14°	-14°
				14°	0°	0°	14°	10°	0°	0°	14°	10°
				-	-	-	-	.045"	.051"	-	.045"	.045"
				.022"	.022"	.022"	.022"	.022"	.022"	.018"	.022"	.022"
												
Medidas Size	Bandas Bands	R	Qty	20.10.211	20.30.200	20.30.241	20.10.417	20.35.402	20.40.431	20.40.163	20.10.611	20.35.501
		L		20.10.212			20.10.418	20.35.403			20.10.612	20.35.502
29	40.22.290	R L	2	47.11.001	-	-	47.21.001	-	-	-	47.31.001	-
29,5	40.22.295	R L	2	47.11.002	-	-	47.21.002	-	-	-	47.31.002	-
30	40.22.300	R L	2	47.11.003	-	-	47.21.003	-	-	-	47.31.003	-
30,5	40.22.305	R L	2	47.11.004	-	-	47.21.004	-	-	-	47.31.004	-
31	40.22.310	R L	2	47.11.005	-	-	47.21.005	-	-	-	47.31.005	-
31,5	40.22.315	R L	2	47.11.006	-	-	47.21.006	-	-	-	47.31.006	-
32	40.22.320	R L	2	47.11.007	47.11.107	-	47.21.007	-	-	47.21.607	47.31.007	47.31.107
32,5	40.22.325	R L	2	47.11.008	47.11.108	-	47.21.008	-	47.21.208	47.21.608	47.31.008	47.31.108
33	40.22.330	R L	2	47.11.009	47.11.109	-	47.21.009	-	47.21.209	47.21.609	47.31.009	47.31.109
33,5	40.22.335	R L	2	47.11.010	47.11.110	-	47.21.010	47.21.110	47.21.210	47.21.610	47.31.010	47.31.110
34	40.22.340	R L	2	47.11.011	47.11.111	47.11.211	47.21.011	47.21.111	47.21.211	47.21.611	47.31.011	47.31.111
34,5	40.22.345	R L	2	47.11.012	47.11.112	47.11.212	47.21.012	47.21.112	47.21.212	47.21.612	47.31.012	47.31.112
35	40.22.350	R L	2	47.11.013	47.11.113	47.11.213	47.21.013	47.21.113	47.21.213	47.21.613	47.31.013	47.31.113
35,5	40.22.355	R L	2	47.11.014	47.11.114	47.11.214	47.21.014	47.21.114	47.21.214	47.21.614	47.31.014	47.31.114
36	40.22.360	R L	2	47.11.015	47.11.115	47.11.215	47.21.015	47.21.115	47.21.215	47.21.615	47.31.015	47.31.115
36,5	40.22.365	R L	2	47.11.016	47.11.116	47.11.216	47.21.016	47.21.116	47.21.216	47.21.616	47.31.016	47.31.116
37	40.22.370	R L	2	47.11.017	47.11.117	47.11.217	47.21.017	47.21.117	47.21.217	47.21.617	47.31.017	47.31.117
37,5	40.22.375	R L	2	47.11.018	47.11.118	47.11.218	47.21.018	47.21.118	47.21.218	47.21.618	47.31.018	47.31.118
38	40.22.380	R L	2	47.11.019	47.11.119	47.11.219	47.21.019	47.21.119	47.21.219	47.21.619	47.31.019	47.31.119
38,5	40.22.385	R L	2	47.11.020	47.11.120	47.11.220	47.21.020	47.21.120	47.21.220	47.21.620	47.31.020	47.31.120
39	40.22.390	R L	2	47.11.021	47.11.121	47.11.221	47.21.021	47.21.121	47.21.221	47.21.621	47.31.021	47.31.121
39,5	40.22.395	R L	2	47.11.022	47.11.122	47.11.222	47.21.022	47.21.122	47.21.222	47.21.622	47.31.022	47.31.122
40	40.22.400	R L	2	47.11.023	47.11.123	47.11.223	47.21.023	47.21.123	-	47.21.623	47.31.023	47.31.123
40,5	40.22.405	R L	2	47.11.024	47.11.124	-	47.21.024	47.21.124	-	47.21.624	47.31.024	-
41	40.22.410	R L	2	47.11.025	47.11.125	-	47.21.025	47.21.125	-	47.21.625	47.31.025	-
41,5	40.22.415	R L	2	47.11.026	47.11.126	-	47.21.026	47.21.126	-	47.21.626	47.31.026	-
42	40.22.420	R L	2	47.11.027	47.11.127	-	47.21.027	47.21.127	-	47.21.627	47.31.027	-

Banda Anatômica Inferior com tubo e acessório Anatomical Band Lower with tube and accessory				Tubo Simples Single Tube	Gancho Hook	Tubo Duplo Double Tube	Tubo Lingual Lingual Tube
Prescrição / Prescription				Roth	-	Roth	-
Torque / Torque				-30°	-	-30°	-
Distal - Offset				4°	-	4	-
Tubo / Tube Ø				-	-	-	-
Slot				.022"	-	.022"	2x .036"
							
Medidas Size	Bandas Bands	R	Qty	20.10.221	30.20.101	20.10.411	20.61.206
		L		20.10.222		20.10.412	
29	40.12.290	R	2	-		-	
		L					
29,5	40.12.295	R	2	-		-	
		L					
30	40.12.300	R	2	-		-	
		L					
30,5	40.12.305	R	2	-		-	
		L					
31	40.12.310	R	2	-		-	
		L					
31,5	40.12.315	R	2	-		-	
		L					
32	40.12.320	R	2	-		-	
		L					
32,5	40.12.325	R	2	48.10.008		-	
		L					
33	40.12.330	R	2	48.10.009		48.20.109	
		L					
33,5	40.12.335	R	2	48.10.010		48.20.110	
		L					
34	40.12.340	R	2	48.10.011		48.20.111	
		L					
34,5	40.12.345	R	2	48.10.012		48.20.112	
		L					
35	40.12.350	R	2	48.10.013		48.20.113	
		L					
35,5	40.12.355	R	2	48.10.014		48.20.114	
		L					
36	40.12.360	R	2	48.10.015		48.20.115	
		L					
36,5	40.12.365	R	2	48.10.016		48.20.116	
		L					
37	40.12.370	R	2	48.10.017		48.20.117	
		L					
37,5	40.12.375	R	2	-		48.20.118	
		L					
38	40.12.380	R	2	-		48.20.119	
		L					
38,5	40.12.385	R	2	-		48.20.120	
		L					
39	40.12.390	R	2	-		48.20.121	
		L					
39,5	40.12.395	R	2	-		48.20.122	
		L					
40	40.12.400	R	2	-		48.20.123	
		L					
40,5	40.12.405	R	2	-		48.20.124	
		L					
41	40.12.410	R	2	-		48.20.125	
		L					
41,5	40.12.415	R	2	-		48.20.126	
		L					
42	40.12.420	R	2	-		48.20.127	
		L					

Banda Anômica Superior com tubo e acessório Anatomical Band Upper with tube and accessory				Tubo Simples Single Tube	Gancho Hook	Tubo Triplo Triple Tube	Gancho Hook	Tubo Simples Single Tube	Tubo Lingual Lingual Tube	Tubo Triplo Triple Tube	Tubo Lingual Lingual Tube
Prescrição / Prescription				Roth	-	Roth	-	Roth	-	Roth	-
Torque / Torque				-14°	-	-14°	-	-14°	-	-14°	-
Distal - Offset				14°	-	14°	-	14°	-	14°	-
Tubo / Tube Ø				-	-	.045"	-	-	-	.045"	-
Slot				.022"	-	.022"	-	.022"	2 x .036"	.022"	2x .036"
											
Medidas Size	Bandas Bands	R L	Qty	20.10.211 20.10.212	30.20.101	20.10.611 20.10.612	30.20.101	20.10.211 20.10.212	20.61.206	20.10.611 20.10.612	20.61.206
29	40.22.290	R L	2	-	-	-	-	-	-	48.31.101	-
29,5	40.22.295	R L	2	-	-	-	-	-	-	48.31.102	-
30	40.22.300	R L	2	-	-	-	-	-	-	48.31.103	-
30,5	40.22.305	R L	2	-	-	-	-	-	-	48.31.104	-
31	40.22.310	R L	2	-	-	48.31.005	-	48.11.105	-	48.31.105	-
31,5	40.22.315	R L	2	-	-	48.31.006	-	48.11.106	-	48.31.106	-
32	40.22.320	R L	2	-	-	48.31.007	-	48.11.107	-	48.31.107	-
32,5	40.22.325	R L	2	-	-	48.31.008	-	48.11.108	-	48.31.108	-
33	40.22.330	R L	2	48.11.009	-	48.31.009	-	48.11.109	-	48.31.109	-
33,5	40.22.335	R L	2	48.11.010	-	48.31.010	-	48.11.110	-	48.31.110	-
34	40.22.340	R L	2	48.11.011	-	48.31.011	-	48.11.111	-	48.31.111	-
34,5	40.22.345	R L	2	48.11.012	-	48.31.012	-	48.11.112	-	48.31.112	-
35	40.22.350	R L	2	48.11.013	-	48.31.013	-	48.11.113	-	48.31.113	-
35,5	40.22.355	R L	2	48.11.014	-	48.31.014	-	48.11.114	-	48.31.114	-
36	40.22.360	R L	2	48.11.015	-	48.31.015	-	48.11.115	-	48.31.115	-
36,5	40.22.365	R L	2	48.11.016	-	48.31.016	-	48.11.116	-	48.31.116	-
37	40.22.370	R L	2	48.11.017	-	48.31.017	-	48.11.117	-	48.31.117	-
37,5	40.22.375	R L	2	48.11.018	-	48.31.018	-	48.11.118	-	48.31.118	-
38	40.22.380	R L	2	48.11.019	-	48.31.019	-	48.11.119	-	48.31.119	-
38,5	40.22.385	R L	2	48.11.020	-	48.31.020	-	48.11.120	-	48.31.120	-
39	40.22.390	R L	2	-	-	48.31.021	-	48.11.121	-	48.31.121	-
39,5	40.22.395	R L	2	-	-	48.31.022	-	48.11.122	-	48.31.122	-
40	40.22.400	R L	2	-	-	48.31.023	-	48.11.123	-	48.31.123	-
40,5	40.22.405	R L	2	-	-	48.31.024	-	-	-	48.31.124	-
41	40.22.410	R L	2	-	-	48.31.025	-	-	-	48.31.125	-
41,5	40.22.415	R L	2	-	-	48.31.026	-	-	-	48.31.126	-
42	40.22.420	R L	2	-	-	48.31.027	-	-	-	48.31.127	-

Kits com bandas / Band Kits

Os kits de bandas apresentam, em práticas embalagens, todos os tamanhos de bandas, em quantidades dimensionadas conforme a sua utilização. padronizadas em vermelho para a embalagens de bandas superiores e azul para inferiores. As caixas também são vendidas avulsas. (veja página 105).

Composição dos kits / kits composition

medida / size	28	28,5	29	29,5	30	30,5	31	31,5	32	32,5	33	33,5	34	34,5	35	30,5	36	36,5	37	37,5	38	38,5	39	39,5	40	40,5	41	41,5	42
Qtd / qty	4	4	4	4	4	4	4	8	8	8	8	8	10	10	10	14	16	16	20	20	20	18	10	8	4	4	4	4	4



Kit com bandas universais / Universal band kits

Medidas Size	Qtd Qty	Inferior / Lower	Superior / Upper	Cor Color
		Código / code	Código / code	
		7 6 6 7	7 6 6 7	
	260	-	40.02.900	
	260	40.01.900	-	



Fitas para bandar em rolo / Tape for banding

As fitas para bandar são confeccionadas em aço inoxidável polido e maleável, utilizadas para bandagem de caninos e outros dentes.

Medidas Size	Qtd Qty	Código Code
0,10 x 3,20mm .004" x .125"	8 metros	40.91.001
0,10 x 3,80mm .004" x .150"	8 metros	40.91.002
0,10 x 4,5mm .004" x .180"	8 metros	40.91.003
0,15 x 4,5mm .006" x .180"	8 metros	40.91.004



ARCOS



Diagrama CrNi

Aço Inoxidável



Diagrama NiTi

Superelástico, Thermo-plus e
Curva Reversa

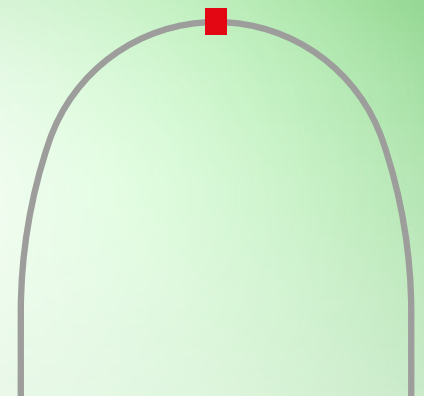
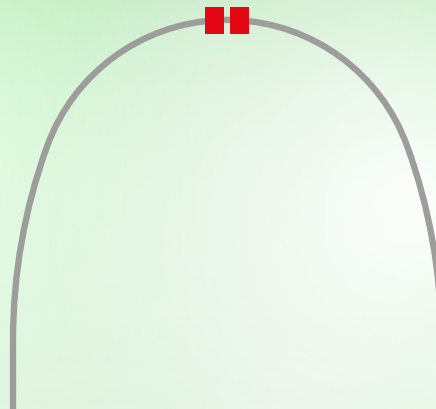
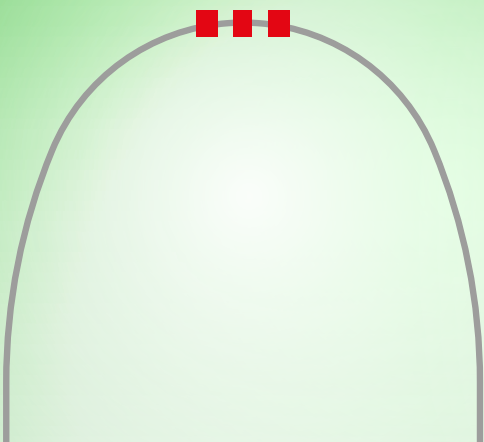

Arco Intraoral CrNi / Intraoral Archwire CrNi

Os arcos ortodônticos de aço inoxidável Morelli apresentam três tipos de secção transversal: redonda, quadrada e retangular.



Identificação Identification	Medidas Size	Qtd Qty	Superior Upper		Inferior Lower	
○	.012" - 0,30mm	10	50.60.000	50.70.000		
○	.014" - 0,35mm	10	50.60.001	50.70.001		
○	.016" - 0,40mm	10	50.60.002	50.70.002		
○	.018" - 0,45mm	10	50.60.003	50.70.003		
○	.020" - 0,50mm	10	50.60.004	50.70.004		
□	.016" x .016" 0,40 x 0,40mm	10	50.61.001	50.71.001		
□	.016" x .022" 0,40 x 0,55mm	10	50.62.001	50.72.001		
□	.017" x .025" 0,43 x 0,63mm	10	50.62.002	50.72.002		
□	.018" x .025" 0,45 x 0,63mm	10	50.62.003	50.72.003		
□	.019" x .025" 0,48 x 0,63mm	10	50.62.004	50.72.004		
□	.021" x .025" 0,53 x 0,63 mm	10	50.62.005	50.72.005		

Arco Intraoral Superelástico NiTi

Intraoral Archwire Superelastic NiTi

As ligas de NiTi (níquel-titânio) são relevantes na biomecânica ortodôntica, pois apresentam superelasticidade e efeitos de memória de forma. Liberam forças suaves e constantes se comparadas ao aço inoxidável. Não sofrem deformação permanente, ou seja, os fios não podem ser dobrados. Os arcos de NiTi Morelli são apresentados nos modelos Pequeno, Médio e Grande.



Identificação Identification	Medidas Size	Qtd Qty	Grande Large			Médio Medium			Pequeno Small		
○	.010" - 0,25mm										
○	.012" - 0,30mm	10				50.70.010					
○	.014" - 0,35mm	10	50.60.011	50.70.011	50.80.011						
○	.016" - 0,40mm	10	50.60.012	50.70.012	50.80.012						
○	.018" - 0,45mm	10	50.60.013	50.70.013	50.80.013						
○	.020" - 0,50mm	10	50.60.014	50.70.014	50.80.014						
○	.021" - 0,53mm	10	50.60.015	50.70.015	50.80.015						
□	.016" x .016" 0,40 x 0,40mm	10	50.61.002	50.71.002	50.81.002						
□	.016" x .022" 0,40 x 0,55mm	10	50.62.011	50.72.011	50.82.011						
□	.017" x .025" 0,43 x 0,63mm	10	50.62.012	50.72.012	50.82.012						
□	.018" x .025" 0,45 x 0,63mm	10	50.62.013	50.72.013	50.82.013						
□	.019" x .025" 0,48 x 0,63mm	10	50.62.014	50.72.014	50.82.014						
□	.021" x .025" 0,53 x 0,63 mm	10	50.62.015	50.72.015	50.82.015						

Arco Intraoral Superelástico Curva Reversa NiTi - Spee

Intraoral Archwire Superelastic Reverse Curve NiTi - Spee

Esses arcos são úteis nas situações em que a presença de curva no arco é importante para a biomecânica ortodôntica. Estão disponíveis em diversas espessuras e secções transversais (redonda, quadrada e retangular).

Identificação Identification	Medidas Size	Qtd Qty	Identificação por cor	
			Grande Large	Médio Medium
○	.012" - 0,30mm	10	50.60.021	50.70.021
○	.014" - 0,35mm	10	50.60.022	50.70.022
○	.016" - 0,40mm	10	50.60.023	50.70.023
○	.018" - 0,45mm	10	50.60.024	50.70.024
○	.020" - 0,50mm	10	50.60.034	50.70.034
□	.016" x .016" 0,40 x 0,40mm	10	50.61.003	50.71.003
□	.016" x .022" 0,40 x 0,55mm	10	50.62.021	50.72.021
□	.017" x .025" 0,43 x 0,63mm	10	50.62.022	50.72.022
□	.019" x .025" 0,48 x 0,63mm	10	50.62.023	50.72.023



Arco Intraoral Superelástico Estético NiTi

Intraoral Archwire Superelastic Aesthetic NiTi

Confeccionado em Níquel-Titânio (Nitinol) e cobertura com polímero de alta tecnologia. Os Arcos Intraorais Estéticos Morelli possuem coloração próxima ao esmalte dentário, recobrimento resistente (cerca de 30 dias), material flexível e biocompatível, resistência à manchas e alteração de cor.

Identificação Identification	Medidas Size	Qtd Qty	Identificação por cor	
			Grande Large	Médio Medium
○	.012" - 0,30mm	05	50.60.035	50.70.035
○	.014" - 0,35mm	05	50.60.036	50.70.036
○	.016" - 0,40mm	05	50.60.037	50.70.037
○	.018" - 0,45mm	05	50.60.038	50.70.038
□	.017" x .025" 0,43 x 0,63mm	05	50.62.036	50.72.036
□	.019" x .025" 0,48 x 0,63mm	05	50.62.037	50.72.037



Arco Intraorais Thermo-Plus NiTi

Intraoral Archwire Thermo Plus NiTi

A liga de NiTi termoativado Thermo-Plus sofre transformação microestrutural com alteração térmica. O Arco ao ser resfriado torna-se maleável e inativo. Quando atinge a temperatura do ambiente bucal (acima de 27°C), ativa-se adquirindo memória de forma, gerando força ortodôntica para os movimentos dentários.



Identificação Identification	Medidas Size	Identificação		
		Grande Large	Médio Medium	Pequeno Small
○ .012" - 0,30mm				
○ .014" - 0,35mm		10 50.60.224	50.70.224	50.80.224
○ .016" - 0,40mm		10 50.60.225	50.70.225	50.80.225
○ .018" - 0,45mm		10 50.60.226	50.70.226	50.80.226
○ .020" - 0,50mm		10 50.60.227	50.70.227	50.80.227
○ .020" - 0,50mm		10 50.60.228	50.70.228	50.80.228
□ .016" x .016" 0,40 x 0,40mm		10 50.61.204	50.71.204	50.81.204
□ .016" x .022" 0,40 x 0,55mm		10 50.62.224	50.72.224	50.82.224
□ .017" x .025" 0,43 x 0,63mm		10 50.62.225	50.72.225	50.82.225
□ .018" x .025" 0,45 x 0,63mm		10 50.62.226	50.72.226	50.82.226
□ .019" x .025" 0,48 x 0,63mm		10 50.62.227	50.72.227	50.82.227
□ .021" x .025" 0,53 x 0,63 mm		10 50.62.228	50.72.228	50.82.228

Arco Intraoral Copper NiTi

Intraoral Archwire Copper NiTi

Os arcos intraorais Copper NiTi Morelli são projetados especialmente para proporcionar o melhor desempenho clínico ao sistema de bráquetes autoligados.

A adição de cobre em 6% na composição da liga potencializa as propriedades térmicas do níquel-titânio, resultando na entrega de forças ideais, com incomparável eficiência da movimentação dentária.











Identificação Identification	Medidas Size	Identificação	
		Superior Upper	Inferior Lower
○ .014" - 0,35mm			
○ .016" - 0,40mm		10 50.60.150	50.70.150
○ .018" - 0,45mm		10 50.60.151	50.70.151
○ .018" - 0,45mm		10 50.60.152	50.70.152
□ .014" x .025" 0,35 x 0,63mm		10 50.62.150	50.72.150
□ .016" x .022" 0,40 x 0,55mm		10 50.62.151	50.72.151
□ .017" x .025" 0,43 x 0,63mm		10 50.62.152	50.72.152
□ .018" x .025" 0,45 x 0,63mm		10 50.62.153	50.72.153
□ .019" x .025" 0,48 x 0,63mm		10 50.62.154	50.72.154

Arco Intraoral Superelástico Rhodium NiTi

Intraoral Archwire Superelastic Rhodium NiTi

Desenvolvidos a partir dos arcos NiTi Superelásticos, os arcos com cobertura de Rhodium proporcionam excelente estética aliada ao desempenho mecânico, mantendo a liberação de forças clínicas leves e constantes durante todo o tratamento. Os Arcos de Rhodium Morelli são recobertos por uma fina camada de ródio, um metal precioso com coloração branco prateado, que proporciona um ótimo efeito estético quando aplicado no ambiente intraoral. O aspecto esbranquiçado deste metal se assemelha a cor dos dentes, garantindo um excelente resultado visual

Medidas Size	Qtd Qty	Grande Large	Médio Medium
			
 .012" - Ø 0,30mm	01	50.60.135	50.70.135
 .014" - Ø 0,35mm	01	50.60.136	50.70.136
 .016" - Ø 0,40mm	01	50.60.137	50.70.137
 .018" - Ø 0,45mm	01	50.60.138	50.70.138
 .017" x .025" 0,43 x 0,63mm	01	50.62.136	50.72.136
 .019" x .025" 0,48 x 0,63mm	01	50.62.137	50.72.137



Kit de Arcos Intraorais para Autoligados

Archwire kit for Selfligating

A própria embalagem é um livreto explicativo sobre a aplicação arcos e suas respectivas forças. Os Arcos e as sugestões de uso apresentadas não dispensam a avaliação criteriosa do profissional habilitado, para adequar o tratamento ao diagnóstico e à resposta biológica de cada paciente.

SEQUÊNCIA DE **ARCOS** + **completa** do mercado

Tipo Type	Qtd Qty	Medidas Size	Código Code
Superelástico - NiTi	20 un*	Ø.010"	50.14.901
Thermo-Plus - NiTi		Ø.012" / Ø.014" / Ø.016" .016"x.016" / .016"x.022" .017"x.025" / .021"x.025"	
		.019"x.025"	
		.017"x.025"	

***10** pares de diferentes arcos
Cada medida contém 2 arcos, sendo um superior e outro inferior.

10 different pairs
Each size contains 2 archwires, lower and upper.



Arcos extraorais

Os arcos extraorais Morelli são confeccionados em aço inoxidável, com alta resistência e maleabilidade. Juntamente com os vários tipos de casquetes e talas cervicais, estes dispositivos exibem versatilidade no ângulo da aplicação, permitindo a obtenção de forças ortodônticas ou ortopédicas. Acompanha exclusiva bolsa para arcos na cor fumê.

Tipo Type	Medidas Size	Qtd Qty	Código Code
Standard		1	50.10.001
		1	50.11.001

Médio Duro		1	50.10.002
		1	50.11.002
Médio Duro Pequeno		1	50.10.003
Médio Brando		1	50.10.005



Acompanha bolsa exclusiva na cor fumê.
Accompanies exclusive grey bag.

Placa lábio-ativa / Lip bumper

As placas lábio-ativas Morelli são construídas em aço inoxidável e plástico injetado, com excelente polimento e lisura superficial. Podem ser utilizadas para reforço de ancoragem, movimentação de molares e tratamento da hipotonia labial.



Código 1: Placa lábio-ativa sem gancho
Limp bumper without hook

Cores Colors	Medidas Size	Qtd Qty	Código 1 Code 1	Código 2 Code 2
 Azul Blue	Ø1,15mm - .045"	1	50.40.002	50.50.002
 Pérola Pearl	Ø1,15mm - .045"	1	50.40.006	50.50.006
 Rosa Pink	Ø1,15mm - .045"	1	50.40.007	50.50.007



Código 2: Placa lábio-ativa com gancho
Lip bumper with hook

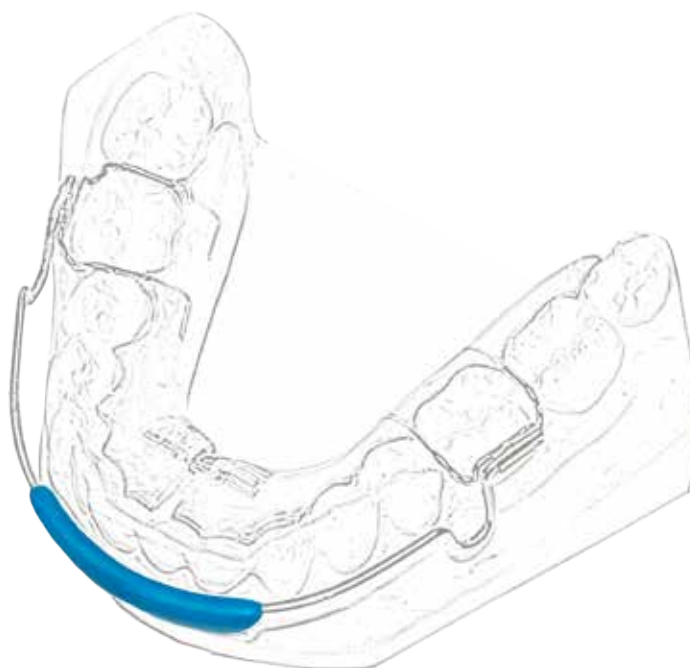

FIOS



Fio em vareta Morest CrNi / Morest CrNi wire in stick

Varetas de fio de aço inoxidável, disponíveis nos diâmetros necessários para todas as etapas do tratamento ortodôntico.

Medidas Size	Qty Qty	Código Code	Qty Qty	Código Code
○ .012" - 0,30mm	10	55.01.012	20	55.06.030
○ .014" - 0,35mm	10	55.01.014	20	55.06.035
○ .016" - 0,40mm	10	55.01.016	20	55.06.040
○ .018" - 0,45mm	10	55.01.018	20	55.06.045
○ .020" - 0,50mm	10	55.01.020	20	55.06.050
○ .024" - 0,60mm	-	-	20	55.06.060
○ .028" - 0,70mm	-	-	20	55.06.070
○ .032" - 0,80mm	-	-	20	55.06.080
○ .036" - 0,90mm	-	-	20	55.06.090
○ .040" - 1,00mm	10	55.06.100	-	-
○ .047" - 1,20mm	10	55.06.120	-	-
□ .016" x .016" 0,40 x 0,40mm	10	55.02.002	-	-
□ .016" x .022" 0,40 x 0,55mm	10	55.03.011	-	-
□ .017" x .022" 0,43 x 0,55mm	10	55.03.016	-	-
□ .017" x .025" 0,43 x 0,63mm	10	55.03.012	-	-
□ .018" x .025" 0,45 x 0,63mm	10	55.03.013	-	-
□ .019" x .025" 0,48 x 0,63mm	10	55.03.014	-	-
□ .021" x .025" 0,53 x 0,63 mm	10	55.03.015	-	-

360mm



Fio em vareta twist-flex CrNi / Twist-flex CrNi Wire in stick

O fio twist-flex está indicado para os primeiros estágios do tratamento ortodôntico, bem como para confecção de barras linguais de contenção.

3 fios	⊗ .015" - 0,38mm	10	55.04.315
	⊗ .018" - 0,45mm	10	55.04.318
	⊗ .020" - 0,50mm	10	55.04.320
4 fios	⊗ .015" - 0,38mm	10	55.04.415

360mm



Fio em vareta twist-flex para barra lingual

Twist-flex CrNi in stick for lingual bar

3 fios	⊗ .032" - 0,80mm	10	55.04.332
--------	------------------	----	-----------

360mm



Fio em vareta ponta azul morealloy CoCr

Blue tip morealloy CoCr Wire in stick

Fios de cobalto-cromo, com níveis de força adequadas à técnica bioprogressiva.

Medidas Size	Qtd Qty	Código Code
<input type="checkbox"/> .016" x .016" 0,40 x 0,40mm	10	55.02.001
<input type="checkbox"/> .016" x .022" 0,40 x 0,55mm	10	55.03.001
<input type="checkbox"/> .017" x .025" 0,43 x 0,63mm	10	55.03.002

360mm

Fio em vareta TMA® / TMA® Wire in stick

A liga especial de titânio-molibdênio dos fios Morelli TMA® traz inúmeras vantagens nas finalizações dos tratamentos ortodônticos pelas características de capacidade de dobras, solda e memória de forma, além da grande elasticidade dos fios.

<input type="radio"/> .012" - 0,30mm	10	56.01.001
<input type="radio"/> .014" - 0,35mm	10	56.01.002
<input type="radio"/> .016" - 0,40mm	10	56.01.003
<input type="radio"/> .018" - 0,45mm	10	56.01.004
<input type="radio"/> .020" - 0,50mm	10	56.01.005
<input type="radio"/> .032" - 0,80mm	10	56.01.006
<input type="radio"/> .036" - 0,90mm	10	56.01.007
<input type="checkbox"/> .016" x .016" 0,40 - 0,40mm	10	56.02.001
<input type="checkbox"/> .016" x .022" 0,40 - 0,55mm	10	56.03.001
<input type="checkbox"/> .017" x .025" 0,43 - 0,63mm	10	56.03.003
<input type="checkbox"/> .018" x .025" 0,45 - 0,63mm	10	56.03.004
<input type="checkbox"/> .019" x .025" 0,48 - 0,63mm	10	56.03.005
<input type="checkbox"/> .021" x .025" 0,53 - 0,63mm	10	56.03.006

360mm

A marca TMA® é de propriedade exclusiva da Dental Morelli Ltda, no Brasil.

The TMA® brand is the inclusive property of Dental Morelli Ltda, in Brazil

Fio redondo de aço inoxidável

Fios de aço inoxidável, com secção transversal redonda, são utilizados com diversas finalidades na Ortodontia, como na confecção de aparelhos removíveis. Disponíveis em rolos de 50g ou 500g.

Fio em rolo duro elástico CrNi - 50g / Hard elastic wire CrNi - 50g

Medidas Size	Metragem aproximada Aproximated measure	Código Code
<input type="radio"/> .012" - 0,30mm	90m	55.01.030
<input type="radio"/> .014" - 0,35mm	66m	55.01.035
<input type="radio"/> .016" - 0,40mm	50m	55.01.040
<input type="radio"/> .018" - 0,45mm	40m	55.01.045
<input type="radio"/> .020" - 0,50mm	32m	55.01.050
<input type="radio"/> .024" - 0,60mm	22m	55.01.060
<input type="radio"/> .028" - 0,70mm	16m	55.01.070
<input type="radio"/> .032" - 0,80mm	12m	55.01.080
<input type="radio"/> .036" - 0,90mm	10m	55.01.090
<input type="radio"/> .040" - 1,00mm	08m	55.01.100
<input type="radio"/> .047" - 1,20mm	05m	55.01.120



Fio em rolo duro elástico CrNi - 500g

Hard elastic wire CrNi - 500g

Medidas Size	Metragem aproximada Approximated measure	Código Code
○ .028" - 0,70mm	165m	55.01.570
○ .032" - 0,80mm	126m	55.01.580
○ .036" - 0,90mm	100m	55.01.590
○ .040" - 1,00mm	81m	55.01.591



Fio em rolo duro elástico meia cana CrNi

Hard elastic half-cane wire CrNi

Fio de perfil especial para confecção de grampos de apoio oclusal, oferece grande estabilidade aos aparelhos ortopédicos inferiores, tipo Planas e outros.

⌒ - Ø 1,30 x 0,65mm	5m	55.01.130
⌒ - Ø 1,50 x 0,75mm	5m	55.01.150
⌒ - Ø 1,75 x 0,90mm	5m	55.01.175
⌒ - Ø 2,00 x 1,00mm	5m	55.01.200



Fio em rolo para amarrilho CrNi - 50g

Ligature wire - 50g

○ .008" - 0,20mm	201m	55.01.208
○ .010" - 0,25mm	130m	55.01.210
○ .012" - 0,30mm	90m	55.01.212



Fio em rolo estético para amarrilho CrNi

Aesthetic wire for ligature CrNi in roll

(D1) Fio Interno Internal wire .010" - 0,25mm	10 m	55.01.220
(D2) Fio Externo External wire .014" - 0,35mm		

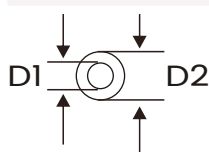

ELÁSTICOS

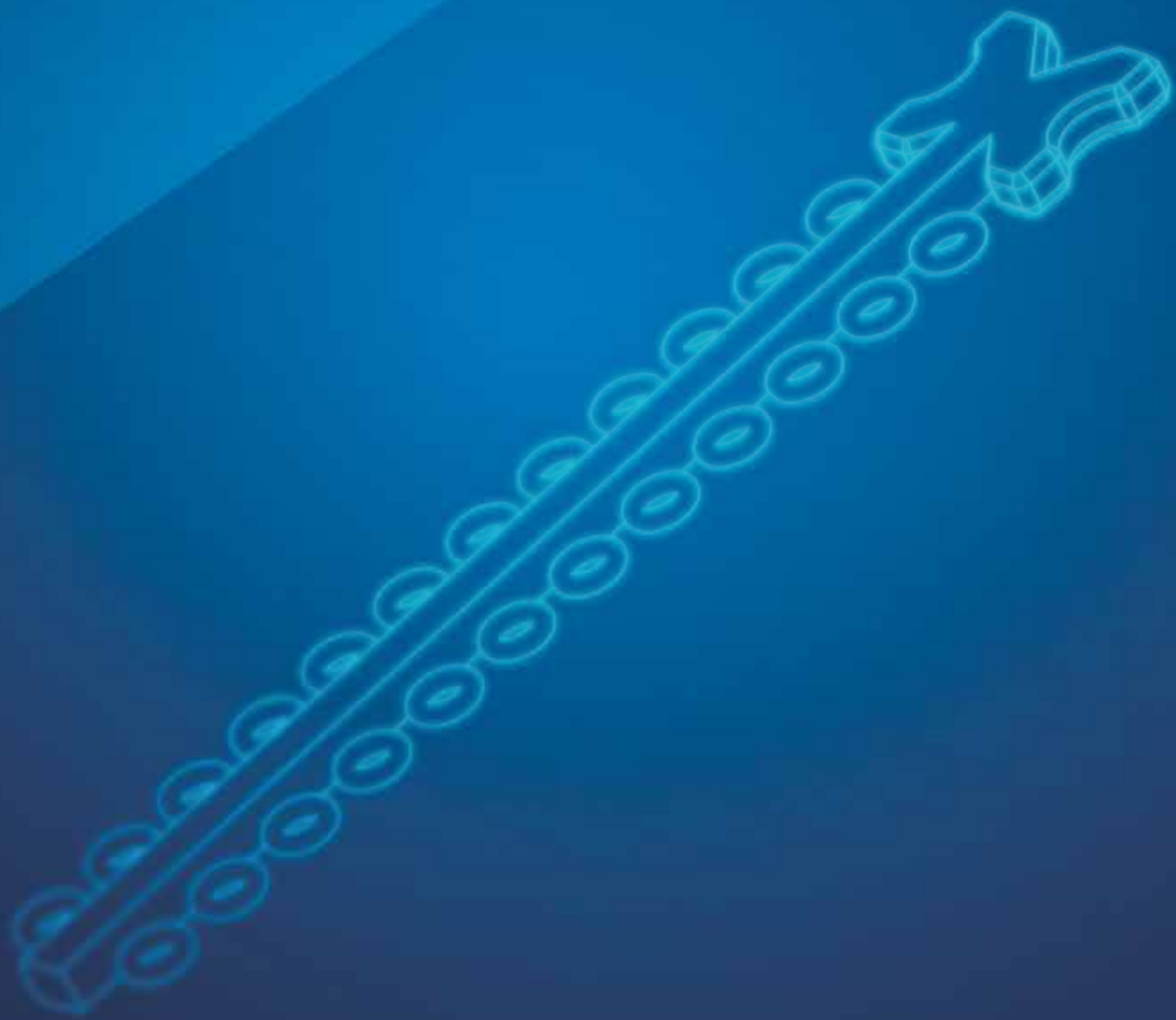

Elásticos para ligadura / Elastic ligatures

Os elásticos para ligaduras Morelli utilizam poliuretano controlado em processo próprio de fabricação e pigmentação atóxica. Apresentado em diversas cores nas versões de bengalinha e modular. Esses elásticos mantêm eficientes níveis de memória e baixos índices de deformação no ambiente bucal.



Bengalinha



Modular

	Cor Colors	Qtd Anéis Qty Rings	Bengalinha Stick	Modular Modular
	Cinza	5000	60.03.701	-
	Cristal	5000	60.03.700	-

	Cinza	1000	60.03.301	60.06.101
	Cristal	1000	60.03.300	60.06.100
	Amarelo	1000	60.03.305	60.06.104
	Azul	1000	60.03.308	60.06.107
	Azul Bebê	1000	60.03.304	60.06.103
	Azul Marinho	1000	60.03.316	60.06.115
	Rosa Pérola	1000	60.03.326	60.06.126
	Marfim	1000	60.03.320	60.06.120
	Rosa	1000	60.03.312	60.06.111
	Prateado	1000	60.03.317	60.06.117
	Preto	1000	60.03.311	60.06.110
	Rosa Bebê	1000	60.03.319	60.06.119
	Roxo	1000	60.03.313	60.06.112
	Verde Musgo	1000	60.03.307	60.06.106
	Verde Mar	1000	60.03.315	60.06.114
	Verde Pérola	1000	60.03.324	60.06.124
	Vermelho	1000	60.03.310	60.06.109
	Vinho	1000	60.03.322	60.06.122
	Lilás	1000	60.03.328	60.06.128
	Branco renda	1000	60.03.327	60.06.127
	Sortida	1000	60.03.302	60.06.118
	Verde Limão Cristal	1000	60.03.350	60.06.150
	Azul Cristal	1000	60.03.354	60.06.154
	Laranja Cristal	1000	60.03.352	60.06.152
	Pink Cristal	1000	60.03.355	60.06.155
	Verde Cristal	1000	60.03.353	60.06.153
	Vermelho Cristal	1000	60.03.351	60.06.151
	Sortido Cristal	1000	60.03.358	60.06.158
	Uva Cristal	1000	60.03.359	60.06.159

As cores impressas são aproximadas, podendo sofrer alterações.

Elásticos em corrente / Elastic chain

Os elásticos em corrente são úteis em mecânicas de fechamento de espaços, retração de anteriores e tracionamento de dentes. São fabricados com material de alta qualidade, oferecendo elasticidade e memória. Disponíveis nas versões de elos curtos, médios e longos, coloridos e em embalagens de 4,5m (cinza e cristal) e 1,5m (demais cores).

Cor Colors	Medidas Size	Qty Qty	Curto Short	Médio Medium	Longo Long	
	Cinza		01	60.05.501	60.05.511	60.05.521
	Cristal		01	60.05.500	60.05.510	60.05.520
	Amarelo		01	60.05.105	60.05.205	60.05.305
	Azul		01	60.05.108	60.05.208	60.05.308
	Azul Bebê		01	60.05.104	60.05.204	60.05.304
	Azul Marinho		01	60.05.116	60.05.216	60.05.316
	Lilás		01	60.05.128	60.05.228	60.05.328
	Marfim		01	60.05.120	60.05.220	60.05.320
	Rosa		01	60.05.112	60.05.212	60.05.312
	Prateado		01	60.05.117	60.05.217	60.05.317
	Preto		01	60.05.111	60.05.211	60.05.311
	Rosa Pérola		01	60.05.126	60.05.226	60.05.326
	Rosa Bebê		01	60.05.119	60.05.219	60.05.319
	Roxo		01	60.05.113	60.05.213	60.05.313
	Verde Musgo		01	60.05.107	60.05.207	60.05.307
	Verde Mar		01	60.05.115	60.05.215	60.05.315
	Verde Cristal		01	60.05.153	60.05.253	60.05.353
	Verde Pérola		01	60.05.124	60.05.224	60.05.324
	Vermelho		01	60.05.110	60.05.210	60.05.310
	Vinho		01	60.05.122	60.05.222	60.05.322
	Branco Renda		01	60.05.127	60.05.227	60.05.327
	Verde Limão Cristal		01	60.05.150	60.05.250	60.05.350
	Azul Cristal		01	60.05.154	60.05.254	60.05.354
	Laranja Cristal		01	60.05.152	60.05.252	60.05.352
	Pink Cristal		01	60.05.155	60.05.255	60.05.355
	Vermelho Cristal		01	60.05.151	60.05.251	60.05.351
	Uva Cristal		01	60.05.159	60.05.259	60.05.359

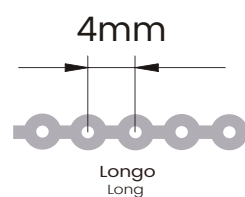
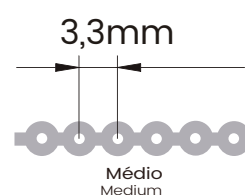
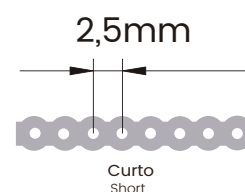



As propriedades elásticas do látex natural são amplamente utilizadas pela Ortodontia através de intercuspidações dentárias de vários níveis, além do tração em conjunto com os arcos extraorais.

Elásticos intraorais 3/4" em látex

Latex intraoral elastics

















Força Force	Cor Colors	Medidas Size	Qtd Qty	Código Code
Leve Light	Natural	 3/4" = 19,05mm	100	60.01.330
Média Medium		 3/4" = 19,05mm	100	60.01.340



Elásticos intraorais em látex

Latex intraoral elastics







Leve Light	Natural	 1/8" = 3,20mm	1000	60.01.200
		 3/16" = 4,80mm	1000	60.01.201
		 1/4" = 6,35mm	1000	60.01.302
		 5/16" = 7,94mm	1000	60.01.303
		 3/8" = 9,53mm	1000	60.01.304
Média Medium	Natural	 1/8" = 3,20mm	1000	60.01.310
		 3/16" = 4,80mm	1000	60.01.311
		 1/4" = 6,35mm	1000	60.01.203
		 5/16" = 7,94mm	1000	60.01.205
		 3/8" = 9,53mm	1000	60.01.314
Pesada Heavy	Natural	 1/8" = 3,20mm	1000	60.01.320
		 3/16" = 4,80mm	1000	60.01.321
		 1/4" = 6,35mm	1000	60.01.322
		 5/16" = 7,94mm	1000	60.01.323
		 3/8" = 9,53mm	1000	60.01.208



Elásticos intraorais em silicone

Silicon intraoral elastics

Os elásticos Intraorais em Silicone Morelli foram desenvolvidos para atender às necessidades mecânicas exigidas pelos bráquetes e acessórios com apelo estético, biocompatível e antialérgico.



Média Medium	Translúcido Translucent	 1/8" = 3,20mm	1000	60.08.110
		 3/16" = 4,80mm	1000	60.08.111
		 1/4" = 6,35mm	1000	60.08.112
		 5/16" = 7,94mm	1000	60.08.113

A força nominal se estabilizará somente após o primeiro alongamento.

The nominal force will stabilize only after the first elongation.



Elásticos em Látex / Latex extraoral elastics

Força Force	Cor Color	Medidas Size	Qtd Qty	Código Code
Leve Light	Natural	 1/2" = 12,7mm	100	60.01.210
Média Medium		 1/2" = 12,7mm	100	60.01.211
Pesada Heavy		 1/2" = 12,7mm	100	60.01.212

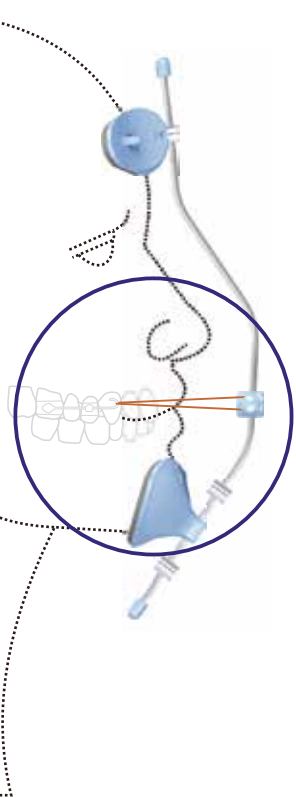

Elásticos separadores / Separator elastics

Os elásticos separadores Morelli atendem às especificações de elasticidade e resistência, promovendo uma eficiente abertura de espaço interproximal.

Formato Format	Cor Color	Medidas Size	Qtd Qty	Código Code
A granel In bulk	 Azul	 5/32" = 4,0mm	1000	60.04.200
	 Verde	 3/16" = 4,80mm	1000	60.04.400
Modular	 Azul	 5/32" = 4,0mm	500	60.04.201
	 Verde	 3/16" = 4,80mm	500	60.04.401



Tubo de proteção / Tube for protection

Este tubo possui a função de proteger a mucosa e os próprios fios, proporcionando reforço e conforto ao paciente.

Além de proteção os tubos coloridos proporcionam efeito decorativo e possibilidade de combinar cores com as demais ligaduras utilizadas no tratamento ortodôntico.

Promovendo o apelo estético que o paciente deseja de forma segura.



Cor Color	Medidas Size	*Diâmetro *Diameter	Qtd Qty	Código Code
Cristal	3,0m	0,75mm	1	60.05.400
Cinza	3,0m	0,75mm	1	60.05.401
Azul	3,0m	0,75mm	1	60.05.403
Pink Cristal	3,0m	0,75mm	1	60.05.405
Cristal	3,0m	0,95mm	1	60.05.410
Cinza	3,0m	0,95mm	1	60.05.411
Azul	3,0m	0,95mm	1	60.05.402
Pink Cristal	3,0m	0,95mm	1	60.05.404

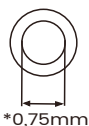

*Diâmetros: 0,75mm p/ fios .012" até .016"x.0;
0,95mm p/ fios .017"x.025" até .0

* Diameters: 0,75mm for wires .012" up to .016" x .022"
0,95mm for wires .017" x .025" up to .021" x .022"

Elásticos rotatores / Rotator elastics

Os elásticos rotatores são posicionados nas aletas dos bráquetes, com finalidade de promover o movimento rotacional do dente.



Cor Color	Qtd Qty	Código Code
Cristal	100	60.07.100
Cinza	100	60.07.101

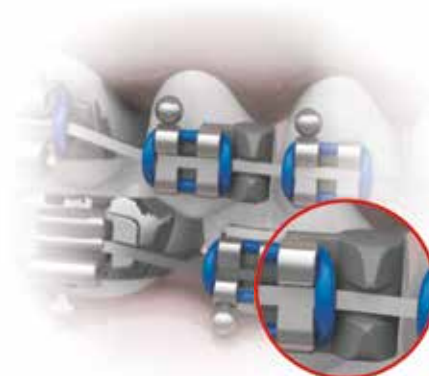

ORTOPEDIA FUNCIONAL

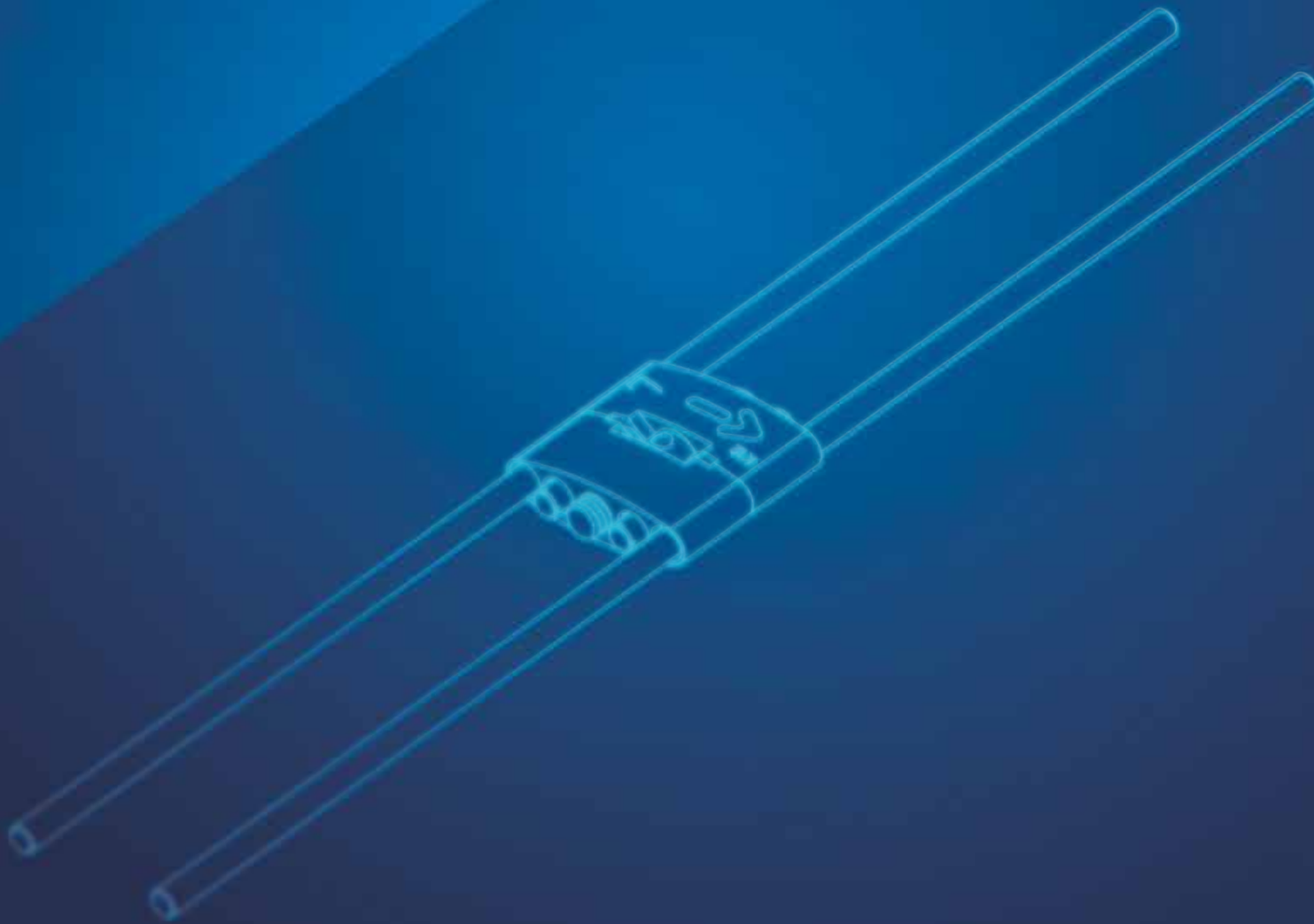

Os expansores Morelli são utilizados em aparelhos fixos ou móveis, para expansão ou disjunção das arcadas dentárias. Estão disponíveis em vários tamanhos e modelos, oferecendo abertura de 5 a 13 mm.

Expansor standard / Standard expansion screw

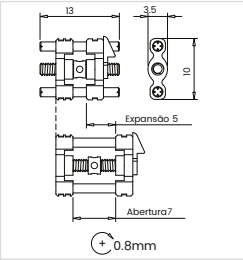
Medidas Size	Abertura Opening	Qtd Qty	Código Code
	7mm	10	65.05.001
	7mm	1	65.05.101
	11mm	10	65.05.009
	11mm	1	65.05.109

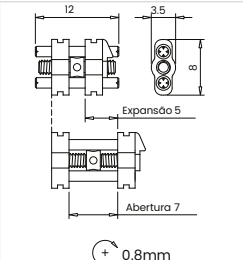
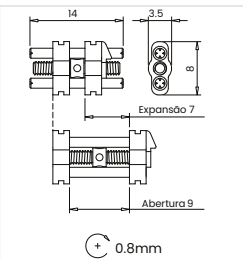

Expansor universal / Universal expansion screw

	7mm	10	65.05.002
	7mm	1	65.05.102
	9mm	10	65.05.003
	9mm	1	65.05.103

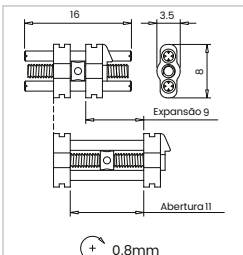

Medidas Size	Abertura Opening	Qtd Qty	Código Code
	11mm	10	65.05.008
	11mm	1	65.05.108



*Expansão: Expansion
Abertura: Opening

Expansor mini / Mini expansion screw



Abertura Opening	Qty Qty	Código Code
6,5mm	10	65.05.006
6,5mm	1	65.05.106

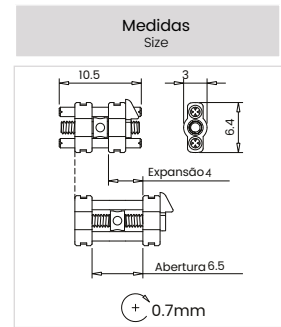

9mm	10	65.05.007
9mm	1	65.05.107

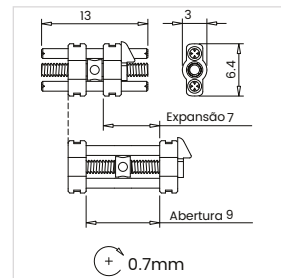

Expansor unilateral mini / Unilateral mini expansion screw



5mm	01	65.05.156
-----	-----------	------------------

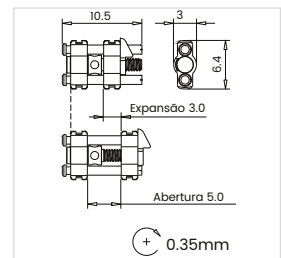

Expansor unilateral / Unilateral expansion screw

6.5mm	1	65.05.151
-------	----------	------------------

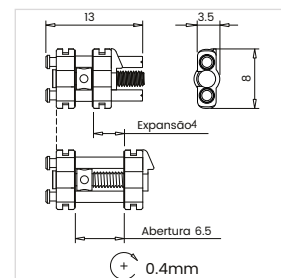

Todos os expansores vêm acompanhados de uma chave de ativação código 75.02.026 - pág 99
 All Expansion Screw are accompanied by an activation key code 75.02.026 - page 99



*Expansão: Expansion
 Abertura: Opening

Expansor em leque / Fan type expansion screw



Medidas Size	Abertura Opening	Qtd Qty	Código Code
	8mm	1	65.05.160

Expansor tipo hyrax para disjunção palatina

Hyrax - Palatal expansion screw



	7mm	1	65.05.010
	9mm	1	65.05.011
	11mm	1	65.05.012
	13mm	1	65.05.013

Expansor - leque rápido borboleta

Rapid fan expansion screw



	10mm	1	65.05.014
--	------	---	------------------

Todos os expansores vêm acompanhados de uma chave de ativação código 75.01.038 - Pág 99
All Expansion Screw are accompanied by an activation key code 75.01.038 - page 99



Escudo de bimler / Bimler Shield

Aparelho que monta e une os arcos inferiores do modelador elástico

Tamanho Size	Qtd Qty	Código Code
médio medium	10	65.01.010



Equiplan planas / Equiplan planas

Único Single	10	65.01.040
-----------------	----	------------------



*Expansão: Expansion
Abertura: opening

CASQUETES E TRACIONADORES

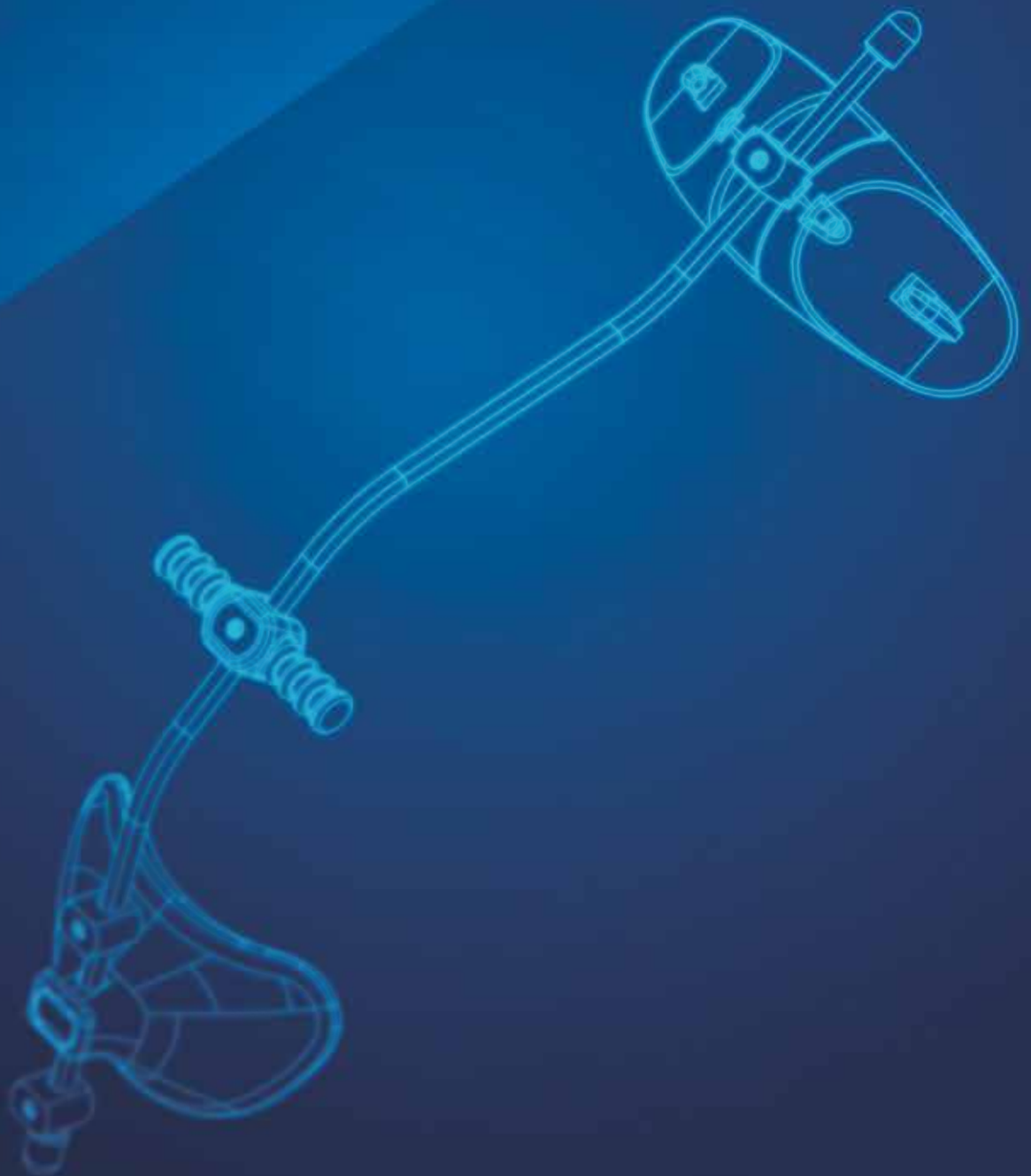

Elástico parietal fivela dupla - tração baixa

Parietal Elastic Double Clasp - low traction



Tamanho Size	Qtd Qty	Código Code
Único one size	1	70.20.011



Tala cervical universal para tração baixa

Universal cervical flap for low traction

Para aplicação de força extra bucal com tração cervical, utilizando tracionadores.



Tamanho Size	Qtd Qty	Código Code
Para Tracionador For Safety Breakaway Device	1	70.20.032

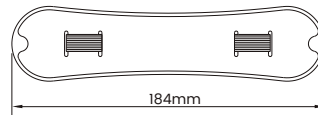

Mentoneira completa - tração alta

Chin cup complete - high traction

Para conter o crescimento mandibular, com aplicação de forças na direção parietal. É fornecida completa ou somente o suporte mentoniano.



único one size	1	70.36.001
-------------------	---	-----------

Mentoneira suporte tracionador do queixo

Chin Cup single

único one size	1	70.36.002
-------------------	---	-----------



Casquetes

Para aplicação de forças extrabuciais com tração alta (occipital).



Casquetes para tracionador

Headgear for Safety Breakaway Device

Tamanho Size	Qtd Qty	Código Code
Pequeno Small	1	70.31.001
Médio Medium	1	70.31.002
Grande Large	1	70.31.003

Casquete - tração regulável Interlandi

Headgear - Adjustable traction Interlandi

É utilizado para ancoragem extrabucal e permite aplicação de forças com angulações diversificadas.

Único one size	01	70.35.001
-------------------	----	-----------



Tracionadores com molas e dispositivo de segurança

Breakaway with traction device

Destrava a presilha espontaneamente, caso a força aplicada exceda o limite.



Qtd Qty	Força leve Light force 350gf	Força média Medium force 500gf	Força pesada Heavy force 750gf
2	70.42.102	70.42.202	70.42.302



Máscara facial de petit

Petit Facial Mask

Aparelho de ancoragem utilizado para tração reversa da maxila com avanço pósterio-anterior. A máscara facial de petit Morelli promove, ao mesmo tempo, uma ação frontal de báscula para baixo e para trás da mandíbula.

Cor Color	Qtd Qty	Código Code
Azul Blue	1	70.50.001
Rosa Pink	1	70.50.002

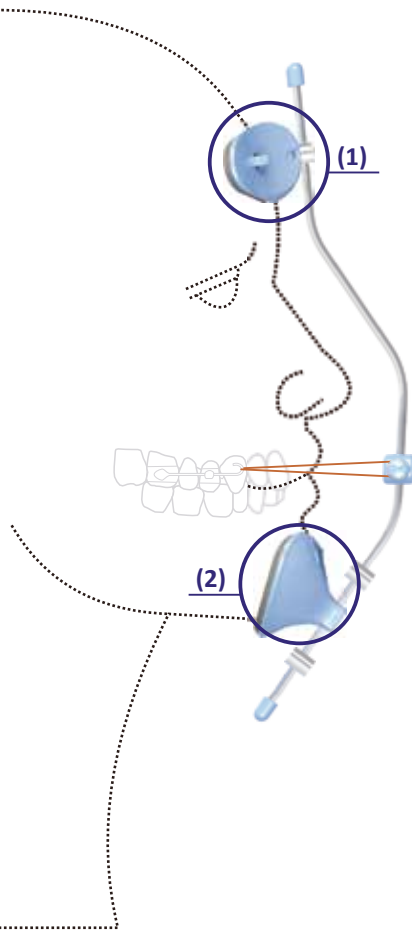

O apoio da testa (1) e a mentoneira (2) possuem proteção de espuma, o que aumenta o conforto e incentiva o paciente ao uso. The forehead support (1) and chin rest (2) have foam protection, which increases comfort and encourages the patient to use.

A máscara facial de petit Morelli possibilita o uso de duas formas: mentoneira fixa ou mentoneira articulada.

It is possible to use Petit Morelli's facial mask in two ways: Fixed or Articulated chin cup.



INSTRUMENTOS

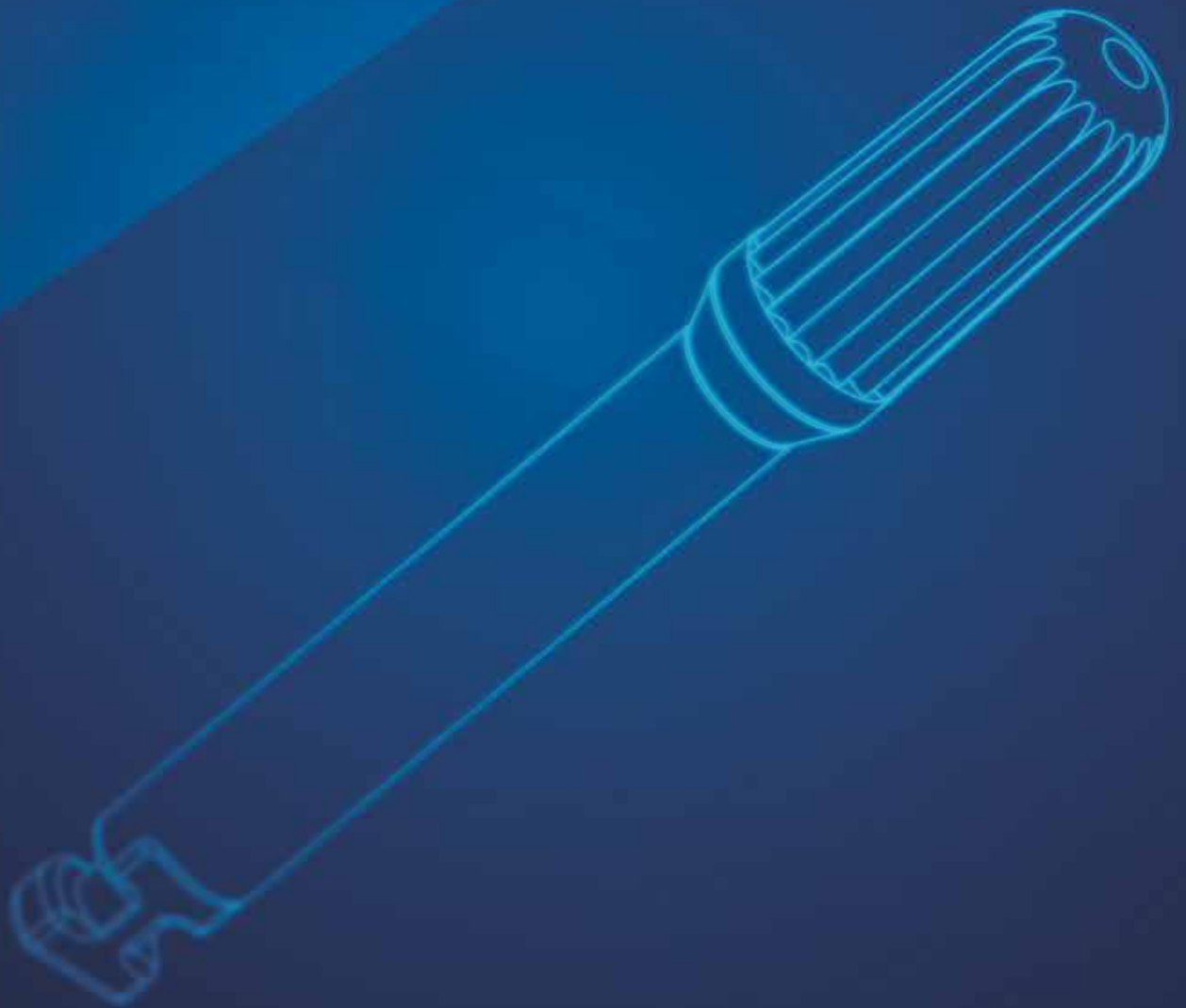

Aplicador de amarrilho

Este instrumento é útil na remoção e colocação de amarrilhos elásticos. Apresentam pontas ativas duplas de aço inoxidável especial.

Aplicadora
Applicator Tip

Aplicador/Extrator de amarrilho elástico Elastic Ligature Applicator/Extractor

Tamanho Size	Qtd Qty	Código Code
-----------------	------------	----------------

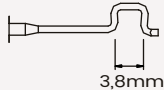
	1	75.01.001
---	---	------------------

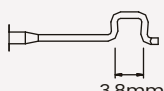
	1	75.01.002
---	---	------------------



Extratora
Extractor Tip

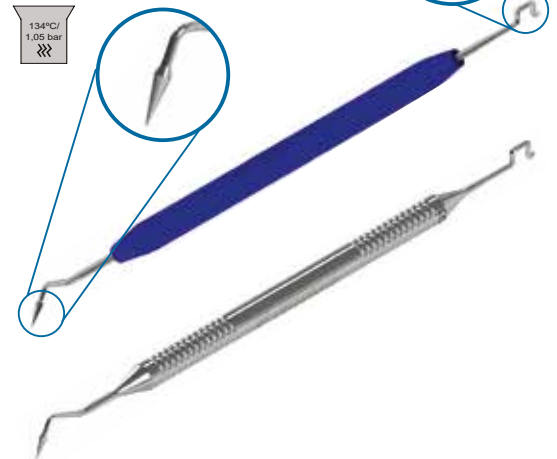

Aplicador de amarrilho elástico Elastic Ligature Applicator

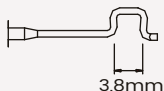
	1	75.01.003
---	---	------------------

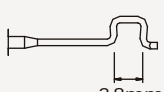
	1	75.01.004
---	---	------------------

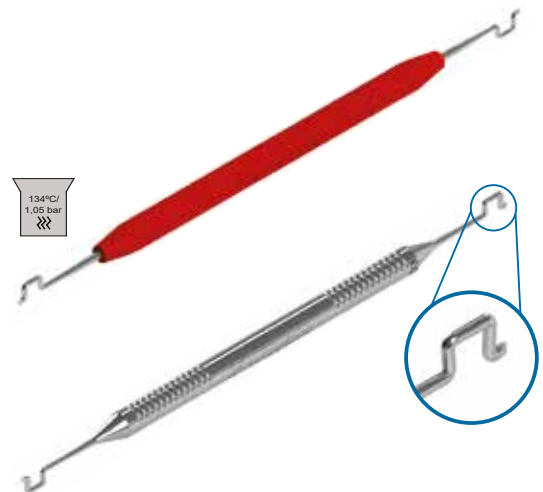

Posicionador de bráquetes / Bracket positioner

Fabricado em aço inoxidável, o posicionador de bráquetes Morelli apresenta exclusiva ponta articulada, que facilita o posicionamento em dentes posteriores. Este instrumento permite o correto posicionamento do slot do bráquete em relação à oclusal ou incisal do dente.

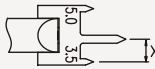
	3,5mm	1	75.01.006
	4,0mm		
	4,5mm		
	5,0mm		
	2,5mm	1	75.01.039
	3,0mm		
	5,5mm		
	6,0mm		

Articulado
Articulated

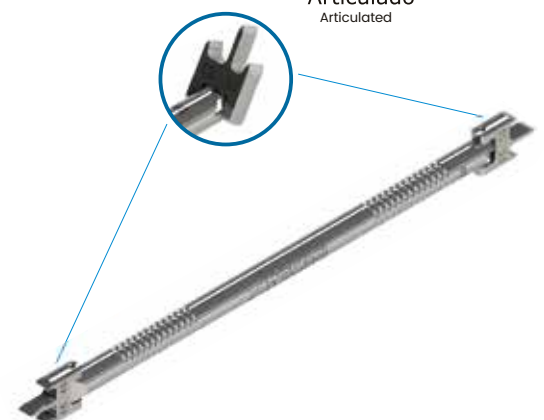

Acalgador de bandas triangular

Band Seater with Triangular Tip



Tamanho Size	Qtd Qty	Código Code
	1	75.01.011

Acalgador de bandas triangular invertido

Band Seater with Invertible Triangular Tip



	1	75.01.012
--	---	------------------

Acalgador de bandas redondo

Band Seater with Round Tip



	1	75.01.013
--	---	------------------

Acalgador de bandas quadrado

Band Seater with Square Tip



	1	75.01.014
--	---	------------------

Moldeiras / Impression trays



As moldeiras Morelli apresentam excelente retenção do alginato devido ao desenho dos sulcos na base, além de permitirem impressão completa da arcada dentária, pela maior altura lateral. Podem ser esterilizadas em autoclave ou quimicamente.

Material Material	Cores Colors	Tamanho Size	Código Code
Plástico Plastic	Cinza Grey	01	75.01.051
	Amarelo Yellow	02	75.01.052
	Rosa Pink	03	75.01.053
	Laranja Orange	04	75.01.054
	Verde Green	05	75.01.055
	Vermelho Red	06	75.01.056
	Azul Blue	07	75.01.057
	Roxa Purple	08	75.01.058

Qtd
1 par



Afastador labial / Lip retractor



Os afastadores labiais Morelli são úteis para otimizar o isolamento durante a colagem direta de acessórios, bem como na realização de fotografias intrabucais.

Tamanho Size	Qtd Qty	Código Code
Pequeno Small	2	75.01.033
Grande Large	2	75.01.043



Pequeno Small	2	75.01.036
Grande Large	2	75.01.046



Torre / Tower

A torre é um instrumento utilizado para conformar arcos ortodônticos a partir de varetas de fios quadrados ou retangulares, de várias espessuras. A Torre Morelli é fabricada em aço inoxidável com manípulo em polímero de engenharia apresentando excelente acabamento e resistência às autoclaves.



Medidas Size	Qtd Qty	Código Code
.016"	1	75.02.005
.017"		
.018"		
.019"		
.021"		



Destacador para tampa de tubos

Removable Cover Tube Detacher

Extraí facilmente a tampa dos tubos conversíveis simples, duplos e triplos. Seu encaixe permite ainda o uso para lâminas de bisturis. As lâminas dos destacadores estão disponíveis para reposição.



Qtd Qty	Código Code
1	75.01.024



Lâmina de destacador

Detacher Blade

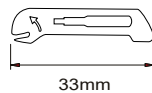

Qtd Qty	Código Code
5	75.01.025



Dobrador de fios

Wire and Rods Bender

O dobrador Morelli é um prático dispositivo para facilitar dobras em fios de grande espessura (Distalizador tipo Hyrax, etc). Possui aberturas e fendas para encaixe de fios, permitindo a utilização de fios de até Ø1,5mm de espessura.

Qtd Qty	Código Code
1	75.02.001



Pinça ortodôntica

Orthodontic Tweezer

A pinça ortodôntica foi desenhada para permitir a apreensão segura e perfeita de bráquetes e acessórios. A extremidade do cabo possui um exclusivo acabamento para facilitar o assentamento e posicionamento de bráquetes.



Qtd Qty	Código Code
1	75.01.022

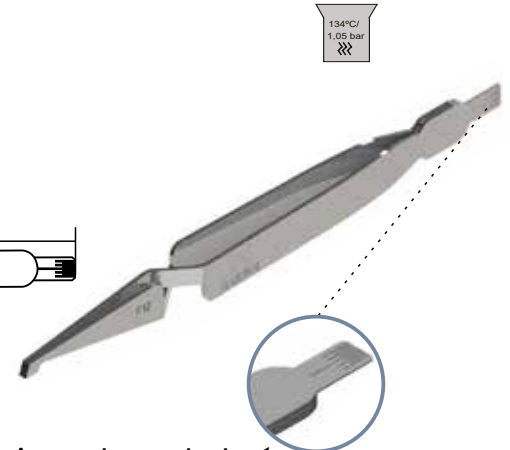

Pinça ortodôntica curta posicionadora de bráquetes

Short Tweezer for Brackets Position

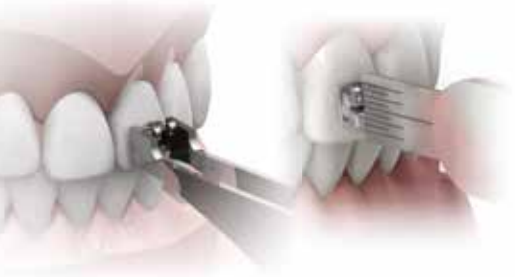

1	75.01.064
---	------------------

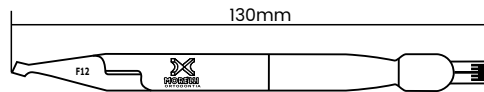

Pinça para tubo

Tweezer for tube

A pinça posicionadora de tubos foi desenvolvida para auxiliar o posicionamento durante a colagem de tubos molares e acessórios em locais de difícil acesso.



1	75.01.027
---	------------------

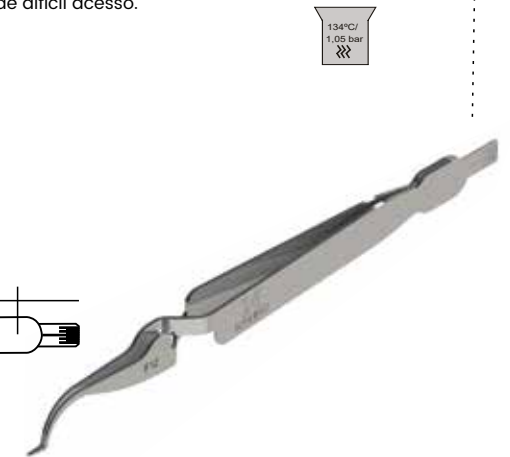
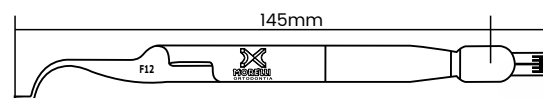

Pinça "Plic"

Plic Tweezer

A pinça "Plic", através da ponta rebaixada, oferece vantagens comprovadas na colocação de elásticos, molas, stops redondos etc.



1	75.01.028
---	------------------

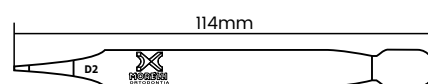



Riscador de bandas

Bands marker

Este instrumento é utilizado para marcar alturas de acessórios nas bandas ortodônticas. Possui mecanismo giratório com medidas de 3,5mm a 5,0mm.



Medidas Size	Qtd Qty	Código Code
	3,5mm	75.01.007
	4,0mm	
	4,5mm	
	5,0mm	



Marcador de bandas tipo estrela

Boone Gauge

Fabricado em aço inoxidável, este instrumento possui pontas tratadas termicamente. É utilizado para riscar bandas e posicionar bráquetes e acessórios.



	3,5mm	1	75.01.023
	4,0mm		
	4,5mm		
	5,0mm		
	2,0mm	1	75.01.029
	2,5mm		
	3,0mm		
	3,5mm		
	4,0mm	1	75.01.030
	4,5mm		
	5,0mm		
	5,5mm		



Dobrador distal fechado

Distal arm bending - Closed slot

Utilizado para dobrar e dar acabamento ao fio ortodôntico por distal, evitando desconforto ao paciente. Apresentado nas versões com furo (fechado) ou com rasgo (aberto) além de curvatura apropriada para facilitar a sua aplicação.



Medidas Size	Qtd Qty	Código Code
.022"	1	75.02.022

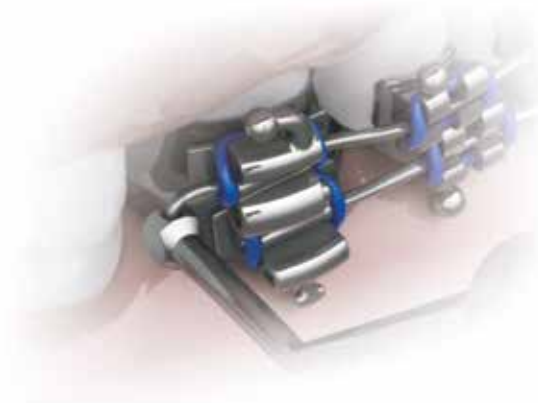

Dobrador distal aberto / Distal Arm bending - Opened slot



Medidas Size	Qtd Qty	Código Code
.022"	1	75.02.023

Dobrador de amarrilho de ponta curva
Arm bending for wire ligature - Curve tip

Os dobradores de amarrilho são úteis para a dobra e acomodação de ligaduras metálicas e elásticas nos canais dos bráquetes e demais aparelhos ortodônticos. Possuem pontas retas e curvas para melhorar ajuste e aplicação.



.022"	1	75.02.074
-------	---	------------------



Curva

Dobrador de amarrilho de ponta reta e curva
Arm bending for ligature wire - Straight/Curve tip

.022"	1	75.02.075
-------	---	------------------



Reta

Tensiômetro ortodôntico
Orthodontic tensiometer

Tensiômetro mecânico utilizado para aferição de forças em elásticos intra e extrabucais. Possuem duas pontas para facilitar o posicionamento.

Cor Color	Força Force	Qtd Qty	Código Code
	100 gf a 1600gf (cN)	1	75.02.001
	50 gf a 500gf (cN)	1	75.02.002
	25 gf a 250gf (cN)	1	75.02.003



Chave sextavada / Hexagonal Key

Chave sextavada para fixação da porca do Gurin (49)

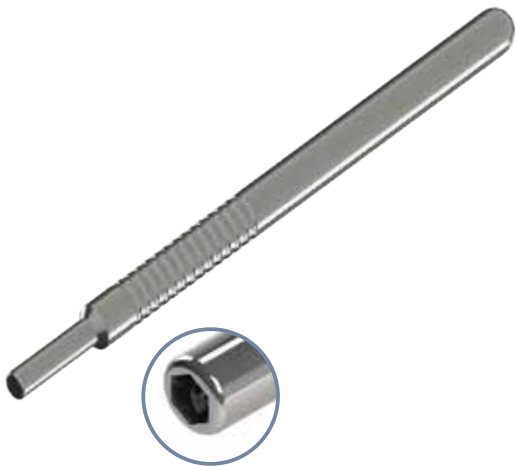

Qtd Qty	Código Code
1	75.02.011



Posicionador de elásticos Elastic positioner

Os posicionadores facilitam a colocação de elásticos feita pelo paciente, conforme a orientação do profissional.



Cor Color	Qtd Qty	Código Code
Azul Blue	20	75.01.015



Veja caixa para elástico nº3 na página 104
See retainer box for elastic nº3 on page 104

Template cefalométrico Benvenga - 1995 Benvenga cephalometric template - 1995



Tamanho Size	Qtd Qty	Código Code
190 x 200mm	1	75.01.020

Chave ativação para expansores Activation key for expansion screws



5	75.01.038
---	------------------

10	75.02.026
----	------------------





Broca em Zircônia Multilâmina

Zirconia Multi Blade Bur for Resin Removal

Indicada para remoção da resina ortodôntica de forma segura, sem danificar ou riscar o esmalte dentário. Uso em contra-ângulo de baixa rotação, **removendo em média até 5 arcadas**.

Diâmetro Diameter	Comprimento Length	Qtd Qty	Código Code
Ø 3 mm	23 mm	5	75.03.001

*Bur removes up to 5 arcades



Eficiência

A Broca Morelli foi desenvolvida especialmente para remover a resina remanescente após a retirada do aparelho.

Reutilizável

Alta resistência aos ciclos de esterilização em autoclave e fácil limpeza dos sulcos, por serem retos.

Ótima finalização

A qualidade da broca causa baixa vibração, o que gera menos calor e superfícies perfeitamente lisas.

Material diferenciado

A única Broca para remoção do mercado injetada inteiramente em zircônia.

Durabilidade

A Broca em Zircônia apresenta uma excelente durabilidade de corte, resistência, não danifica e nem contamina os dentes. É igualmente eficaz em qualquer sentido de giro, o que evita erros e aumenta sua vida útil.

Segurança

Sua ponta ativa multilaminada não machuca a gengiva, o que proporciona a remoção da resina de forma controlada, eliminando o risco de fissurar, riscar o esmalte ou danificar o tecido mole.

Ponta Descartável para Polimento

Disposable Point for Finishing

Ideal para recuperar o brilho e lisura do esmalte dentário após a utilização da Broca em Zircônia Morelli. Uso em contra-ângulo de baixa rotação, **removendo até 1 arcada**.

Diâmetro Diameter	Comprimento Length	Qtd Qty	Código Code
Ø 3 mm	23 mm	20	75.03.002

*Point remove up to 1 arcade



Excelente acabamento

A ponta para polimento proporciona um ótimo acabamento final do esmalte.

Segurança

Seu formato arredondado é mais seguro para a gengiva e permite o acesso a áreas próximas a ela, eliminando qualquer resina remanescente e garantindo um excelente acabamento.

Qualidade do material

Sua composição em polímero com fibra de vidro apresenta abrasividade adequada para a remoção dos resíduos de adesivo, garantindo um polimento eficaz e seguro contra danos ao esmalte dentário.

Praticidade

A Ponta Morelli pode ser aplicada à seco e em qualquer sentido de giro. Por ser descartável, dispensa esterilização.

HIGIENE BUCAL



Escova interdental / Interdental brush

As escovas interdentais são utilizadas para limpeza entre os dentes (interproximal), prevenindo o tártaro e doenças periodontais. São bastante eficientes para a higienização dos aparelhos ortodônticos e alcançam locais de difícil acesso a outros instrumentos de limpeza. As escovas interdentais Morelli auxiliam a profilaxia favorecendo a evolução do tratamento ortodôntico, evitando manchas e cáries nos dentes além de infecções gengivais.

Cor Color	Qtd Qty	Código Code
Branco White	10 Kits	78.01.001
Azul Blue	10 Kits	78.01.002
Amarelo Yellow	10 Kits	78.01.003
Rosa Pink	10 Kits	78.01.004

Kit composto de: 3 escovas, 1 estojo e 1 cabo
Kit composed of: 3 brushes, 1 case and 1 cable.



Refil da escova interdental Refills of interdental brush

Tamanho Size	Qtd Qty	Código Code
Cilíndrico Cylindrical P	10 blisters 60 escovas brushes	78.01.101
Cilíndrico Cylindrical M	10 blisters 60 escovas brushes	78.01.102
Cônico Conical G	10 blisters 60 escovas brushes	78.01.103



Limpa língua / Tongue Cleaner

O limpa língua Morelli tem desenho anatômico e funcional, próprio para remoção da saburra (responsável pelo mau hálito e formação da placa bacteriana), com máxima eficiência e cuidado, sem danificar as papilas da língua;

Cor Color	Qtd Qty	Código Code
Azul e Rosa Blue and Pink	10 pares / pairs 20 unidades / units	78.02.001
Azul e Amarelo Blue and Yellow	10 pares / pairs 20 unidades / units	78.02.002



COMPARTIMENTOS



Caixas de bolso para aparelhos móveis e elásticos

Pocket box for mobile appliances and elastics

Cores Colors	Qtd Qty	Código Code
-----------------	------------	----------------

Azul Blue	10	80.04.211
--------------	----	------------------

Rosa Pink	10	80.04.212
--------------	----	------------------



Cores Colors	Qtd Qty	Caixa 1 aparelhos removíveis Box 1 Removable Appliances	Caixa 2 aparelhos removíveis Box 2 Removable Appliances	Caixa 3 para elásticos Box 3 Elastics
-----------------	------------	--	--	---

Sortida Assorted	10	80.03.004	80.04.001	80.04.002
---------------------	----	------------------	------------------	------------------



Acompanha dispositivo para colocar e extrair elásticos!
Accompany Device for place and remove elastics!

Posicionador de elásticos avulsos código 75.01.015 na página 99
Elastic positioner single code 75.01.015 - page 99





Embalagem para elásticos

Zip bag for elastics

Tamanho Size	Qtd Qty	Código Code
	50	80.05.001

Caixas para bandas e bráquetes

Com fundo arredondado e numeração de bandas e bráquetes, as caixas Morelli são ideais para armazenamento de acessórios, conferindo praticidade e organização ao consultório. São confeccionadas em poliestireno de alto impacto.

Caixa para bandas superiores

Box for upper bands

Tamanho Size	Uso Use	Qtd Qty	Código Code
	Universal	1	80.02.011
	Anatômica direita Anatomical Right	1	80.02.012
	Anatômica esquerda Anatomical Left	1	80.02.013

Caixa para bandas inferiores

Box for lower bands

Tamanho Size	Uso Use	Qtd Qty	Código Code
	Universal	1	80.02.021
	Anatômica direita Anatomical Right	1	80.02.022
	Anatômica esquerda Anatomical Left	1	80.02.023



Caixa para bráquetes

Box for brackets

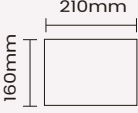
Tamanho Size	Qtd Qty	Código Code
	01	80.02.030



Caixa organizadora multiuso

Multiuse organizer box

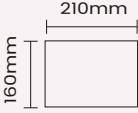
Tamanho Size	Qtd Qty	Código Code
	1	80.06.020

Acompanha 64 etiquetas adesivas, que podem ser coladas na Caixa para identificar os materiais.

Accompanied by 64 adhesive labels, which can be glued in the Box to identify the materials.



ADESIVOS

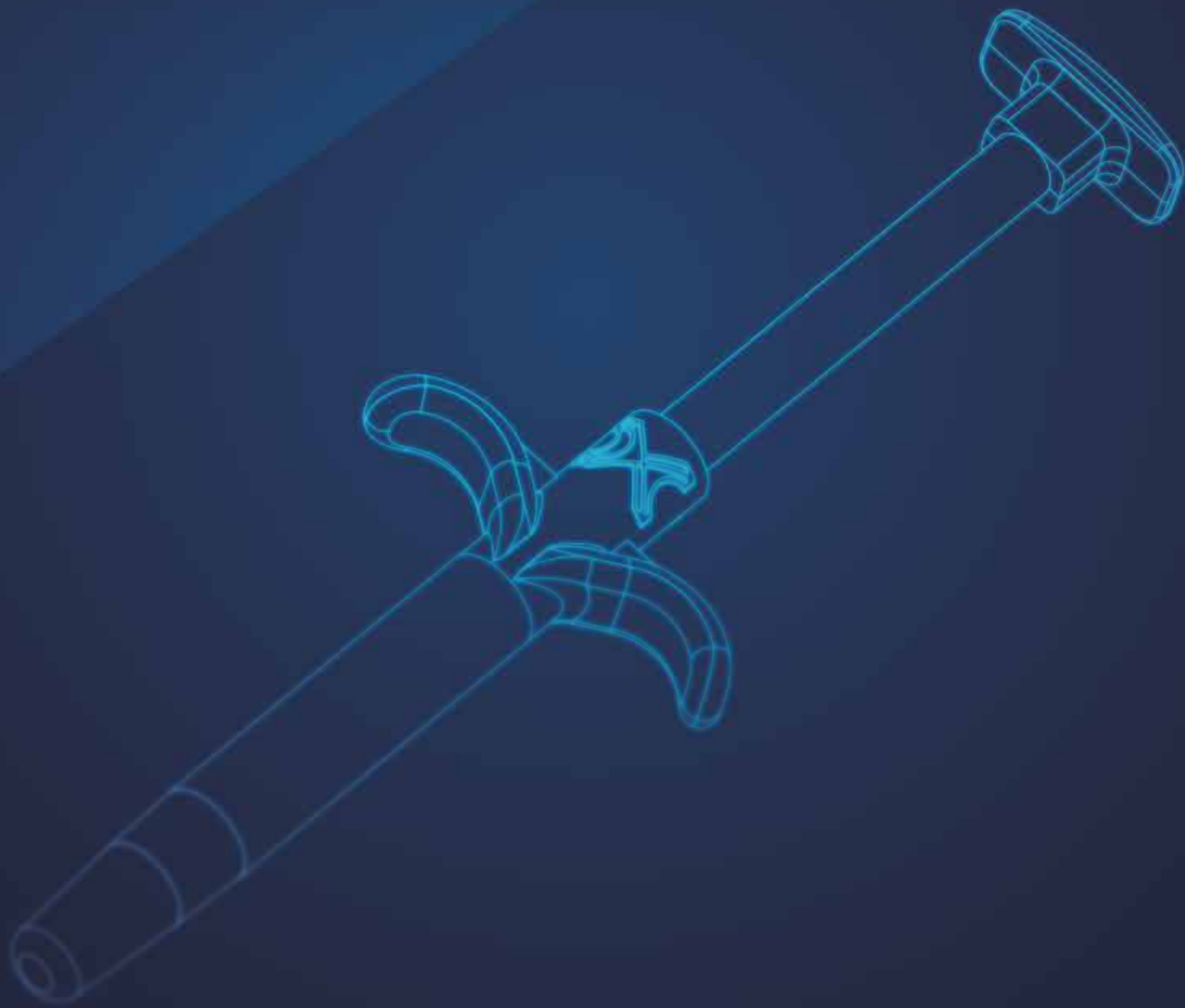

Orthobond Plus Color Change Adhesive

Adesivo ortodôntico fotopolimerizável de alta performance desenvolvido para colagem de bráquetes metálicos, cerâmicos e compósitos, tubos e demais acessórios ao esmalte dentário. O adesivo de colagem ortodôntica Orthobond Plus possui a densidade e resistência adequadas para uma colagem confortável e eficaz. Sua fluidez e consistência foram especialmente projetadas para penetrar nos micro pinos dos Bráquetes Morelli. O adesivo apresenta uma coloração levemente rosa, o que facilita sua visualização durante a aplicação na base das peças destinadas à colagem, especialmente durante o acabamento e remoção de excessos do esmalte dentário. Rende mais de 15 casos completos.

Medida Size	Qtd Qty	Código Code
4 g	1	85.01.017

Efeito Color Change - Ao realizar a fotopolimerização, o adesivo perde o tom de rosa e apresenta uma coloração similar ao dente.

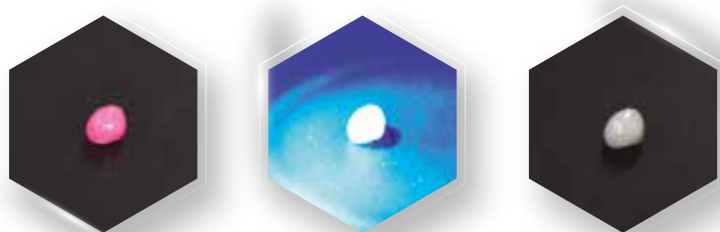

OrthoPrimer

Adesivo fluido utilizado como base para ativação de adesivos ortodônticos fotopolimerizáveis. Possui base fotopolimerizável de alta fluidez para micro penetração nos prismas do esmalte, potencializando as colagens em bráquetes e acessórios. Ensaio laboratoriais comprovam que a aplicação do Orthoprimer, em peças metálicas e cerâmicas, proporciona um aumento da força de adesão em até 20%. Além de ter uso imprescindível em peças de policarbonato/compósito. Rende mais de 50 casos completos.

5 g	1	85.01.016
-----	---	------------------



Confira dicas essenciais de colagem em nosso **Manual de Colagem Ortodôntica.**

Solicite através do nosso site:
www.morelli.com.br/loja/catalogobrindes

CONHEÇA A FÁBRICA

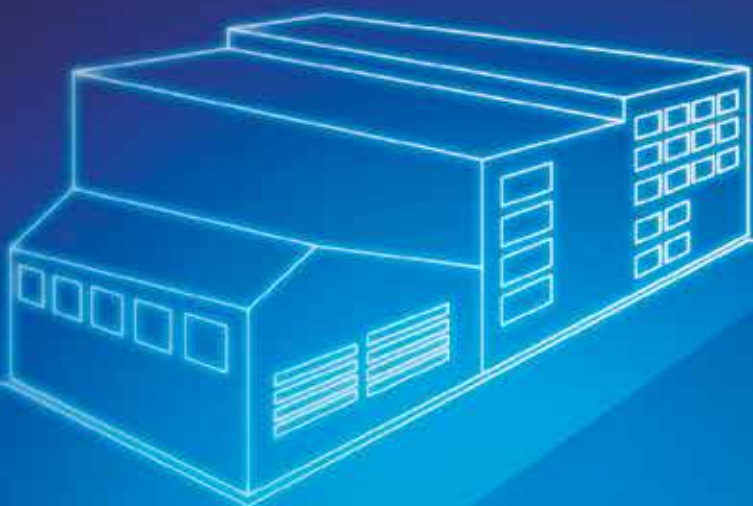

16

ANOS DE PROGRAMA

+ de 500 visitas realizadas
+ de 12 mil visitantes

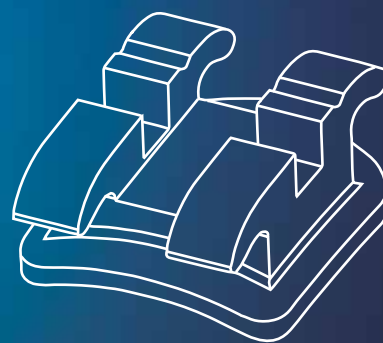

UMA EXPERIÊNCIA
INCRÍVEL

NO MAIOR POLO
INDUSTRIAL
DA AMÉRICA LATINA

ESPECIALIZADO
EM PRODUTOS
ORTODÔNTICOS

VENHA CONHECER A
MORELLI ORTODONTIA

Agende sua visita

Acesse: www.morelli.com.br
informações: 0800-121455



www.morelli.com.br

Catálogo Morelli - Edição nº 8 - 2018

📍 Al. Jundiá, 230/250 • Jd.Saira • Sorocaba-SP • CEP: 18085-090
☎ 0800 12 1455 / 0800 703 1455 • +55 (15) 3238.8200
✉ vendas@morelli.com.br